

ENHULK

20V Cordless Hedge Trimmer ASYHT10

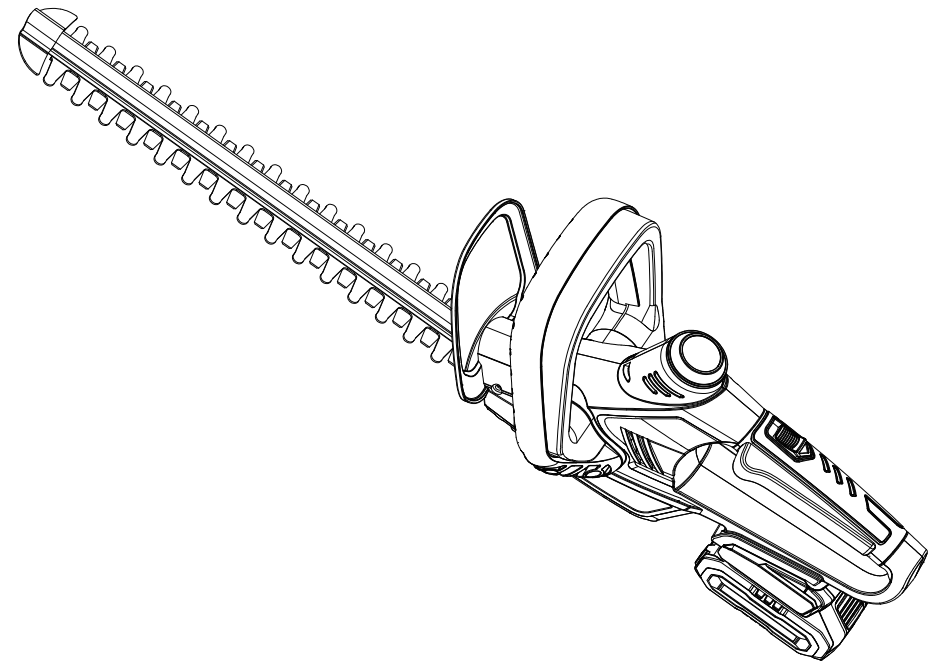

SYVIO TECHNOLOGY CO.,LIMITED
Room A, 8/F,Kwok Cheung Building, 635-637
Shanghai Street, Mong Kok, Hong Kong
0086-133-2298-6467
service@enhulktools.com



**Please read carefully before use
Original instruction Manual**

Safety instructions

General Power Tool Safety Warnings

⚠ WARNING Read all safety warnings, instructions, illustrations and specifications

provided with this power tool. Failure to follow all instructions listed below may result in electric shock, fire and/or serious injury.

Save all warnings and instructions for future reference. The term "power tool" in the warnings refers to your mains- operated (corded) power tool or battery-operated (cordless) power tool.

- **Work area safety**
- **Keep work area clean and well lit.** Cluttered or dark areas invite accidents.
- **Do not operate power tools in explosive atmospheres, such as in the presence of flammable liquids, gases or dust.** Power tools create sparks which may ignite the dust or fumes.
- **Keep children and bystanders away while operating a power tool.** Distractions can cause you to lose control.

Electrical safety

Power tool plugs must match the outlet. Never modify the plug in any way. Do not use any adapter plugs with earthed (grounded) power tools. Unmodified plugs and matching outlets will reduce risk of electric shock.

- **Avoid body contact with earthed or grounded surfaces, such as pipes, radiators, ranges and refrigerators.** There is an increased risk of electric shock if your body is earthed or grounded.
- **Do not expose power tools to rain or wet conditions.** Water entering a power tool will increase the risk of electric shock.
- **Do not abuse the cord. Never use the cord for carrying, pulling or unplugging the power tool. Keep cord away from heat, oil, sharp edges or moving parts.** Damaged or entangled cords increase the risk of electric shock.
- **When operating a power tool outdoors, use an extension cord suitable for outdoor use.** Use of a cord suitable for outdoor use reduces the risk of electric shock.
- **If operating a power tool in a damp location is unavoidable, use a residual current device (RCD) protected supply.** Use of an RCD reduces the risk of electric shock.

Personal safety

- **Stay alert, watch what you are doing and use common sense when operating a power tool. Do not use a power tool while you are tired or under the influence of drugs, alcohol or medication. A moment of inattention while operating power tools may result in serious personal injury.**

- **Use personal protective equipment. Always wear eye protection.** Protective equipment such as a dust mask, nonskid safety shoes, hard hat or hearing protection used for appropriate conditions will reduce personal injuries.
- **Prevent unintentional starting. Ensure the switch is in the off-position before connecting to power source and/or battery pack, picking up or carrying the tool.** Carrying power tools with your finger on the switch or energising power tools that have the switch on invites accidents.
- **Remove any adjusting key or wrench before turning the power tool on.** A wrench or a key left attached to a rotating part of the power tool may result in personal injury.
- **Do not overreach. Keep proper footing and balance at all times.** This enables better control of the power tool in unexpected situations.
- **Dress properly. Do not wear loose clothing or jewellery. Keep your hair and clothing away from moving parts.** Loose clothes, jewellery or long hair can be caught in moving parts.
- **If devices are provided for the connection of dust extraction and collection facilities, ensure these are connected and properly used.** Use of dust collection can reduce dust related hazards.
- **Do not let familiarity gained from frequent use of tools allow you to become complacent and ignore tool safety principles.** A careless action can cause severe injury within a fraction of a second.

Power tool use and care

- **Do not force the power tool. Use the correct power tool for your application.** The correct power tool will do the job better and safer at the rate for which it was designed.
- **Do not use the power tool if the switch does not turn it on and off.** Any power tool that cannot be controlled with the switch is dangerous and must be repaired.
- **Disconnect the plug from the power source and/or remove the battery pack, if detachable, from the power tool before making any adjustments, changing accessories, or storing power tools.** Such preventive safety measures reduce the risk of starting the power tool accidentally.
- **Store idle power tools out of the reach of children and do not allow persons unfamiliar with the power tool or these instructions to operate the power tool.** Power tools are dangerous in the hands of untrained users.
- **Maintain power tools and accessories. Check for misalignment or binding of moving parts, breakage of parts and any other condition that may affect the power tool's operation. If damaged, have the power tool repaired before use.** Many accidents are caused by poorly maintained power tools.

Safety Instructions

- **Keep cutting tools sharp and clean.** Properly maintained cutting tools with sharp cutting edges are less likely to bind and are easier to control.
- **Use the power tool, accessories and tool bits etc. in accordance with these instructions, taking into account the working conditions and the work to be performed.** Use of the power tool for operations different from those intended could result in a hazardous situation.
- **Keep handles and grasping surfaces dry, clean and free from oil and grease.** Slippery handles and grasping surfaces do not allow for safe handling and control of the tool in unexpected situations.

Battery tool use and care

- **Recharge only with the charger specified by the manufacturer.** A charger that is suitable for one type of battery pack may create a risk of fire when used with another battery pack.
- **Use power tools only with specifically designated battery packs.** Use of any other battery packs may create a risk of injury and fire.
- **When battery pack is not in use, keep it away from other metal objects, like paper clips, coins, keys, nails, screws or other small metal objects, that can make a connection from one terminal to another.** Shorting the battery terminals together may cause burns or a fire.
- **Under abusive conditions, liquid may be ejected from the battery; avoid contact. If contact accidentally occurs, flush with water. If liquid contacts eyes, additionally seek medical help.** Liquid ejected from the battery may cause irritation or burns.
- **Do not use a battery pack or tool that is damaged or modified.** Damaged or modified batteries may exhibit unpredictable behaviour resulting in fire, explosion or risk of injury.
- **Do not expose a battery pack or tool to fire or excessive temperature.** Exposure to fire or temperature above 130°C may cause explosion.
- **Follow all charging instructions and do not charge the battery pack or tool outside the temperature range specified in the instructions.** Charging improperly or at temperatures outside the specified range may damage the battery and increase the risk of fire.

Service











- **Have your power tool serviced by a qualified repair person using only identical replacement parts.** This will ensure that the safety of the power tool is maintained.

- **Never service damaged battery packs.** Service of battery packs should only be performed by the manufacturer or authorized service providers.

Hedge trimmer safety warning

- **Keep all parts of the body away from the cutter blade. Do not remove cut material or hold material to be cut when blades are moving.** **Make sure the switch is off when clearing jammed material.** A moment of inattention while operating the hedge trimmer may result in serious personal injury.
- **Carry the hedge trimmer by the handle with the cutter blade stopped. When transporting or storing the hedge trimmer always fit the cutting device cover.** Proper handling of the hedge trimmer will reduce possible personal injury from the cutter blades.
- **Hold the power tool by insulated gripping surfaces only, because the cutter blade may contact hidden wiring.** Cutter blades contacting a "live" wire may make exposed metal parts of the power tool "live" and could give the operator an electric shock.
- **Check the hedge for foreign objects, e.g. wire fences.**
- **Use both hands when operating the hedge trimmer.** Using one hand could cause loss of control and result in serious personal injury.

Symbols

	To reduce the risk of injury, user must read in struction manual		Do not dispose of waste batteries as unsorted municipal waste.
	Always use eye/ear protection, Wear dust mask and safety helmet.		Do not burn
	Do not expose to rain		Do not dispose of batteries. Return exhausted batteries to your local collection or recycling point.
	Keep hands away		
	Keep bystanders away		Waste electrical products must not be disposed of with household Waste. Please recycle where facilities exist. Check with your local authorities or retailer for recycling advice.

Product Description and Specifications

Product Features

Diagram of the hedge trimmer on the graphics page.

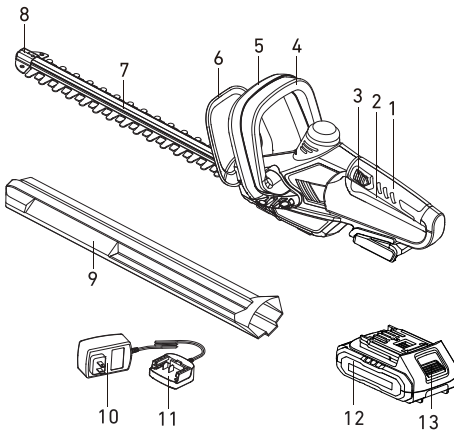

- (1) Rotating handle
- (2) Rear Switch
- (3) Handle lock
- (4) Front switch
- (5) Front handle
- (6) Hand guard
- (7) Blade
- (8) Tip Protector
- (9) Blade guard
- (10) Charger
- (11) Charger connector
- (12) Battery
- (13) Battery release button

Product Description and Specifications

Technical Data

Cordless Hedge Trimmer

Article number	ASYHT10
Voltage	20VDC
No load speed	3000spm
Blade length	20in 510mm
Cutting capacity	0.63in 16mm

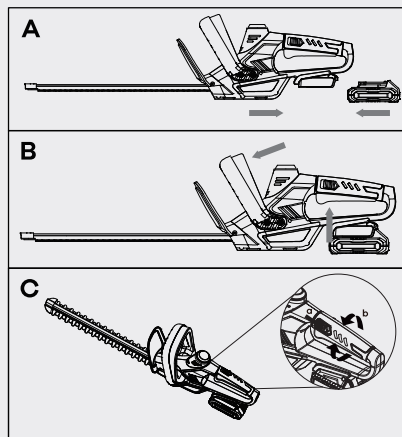

Product Description and Specifications

Assembly

Battery Charging

Use only the chargers listed in the technical data. Only these chargers are matched to the lithium-ion battery of your power tool.

Note: The battery is supplied partially charged. To ensure full battery capacity, fully charge the battery in the charger before using your tool for the first time.

The lithium-ion battery can be charged at any time without reducing its service life.

Interrupting the charging process does not damage the battery.

Fit or remove the battery

The battery is equipped with two locking levels to prevent the battery from falling out if the battery release button is pressed unintentionally. As long as the battery is inserted in the power tool, it is held in position by means of a Spring.

To remove the battery (12), press the release button (13) and pull the battery upwards and out of the power tool. **Do not use force to do this. Follow the instructions on correct disposal. Remove the battery before cleaning or performing maintenance work on the power tool, before making tool adjustments, changing accessories or storing the power tool.** This safety measure prevents the power tool from being started accidentally.

Operation

After fully-charged the battery pack, carefully fit it into the hedge trimmer with a "click". Make sure the battery pack is tight enough fitted with the hedge trimmer.

Starting Operation

To turn on the machine, you should push down Front switch (2) and Rear switch (4) at the same time.

Release any one of the two switch will make the machine a sudden stop, in that case, you will see sparkle from the ventilation slot, do not worry, this is normal and will not damage the machine. You will probably notice a burning smell coming from the motor, again do not worry, as this is the electrical brake which always generates a little smoke.

Rotating handle

See Figure C

The handle can be rotated 45° or 90° to the left or to the right.

To rotate handle:

- Remove the battery pack.
- Press on the rotating handle button.
- Turn handle to the right or to the left.
- Release rotating handle button.
- Keep turning handle until it locks into place in one of the 45° or 90° positions.

Product Description and Specifications

How to use your hedge trimmer

- Note that the back handle can be adjusted on 5 positions, giving you 5 choices for a comfortable grip. Before cutting, inspect the area first and remove any foreign objects that could become thrown or entangled in the blades.
- Always hold the trimmer with both hands and with the blade away from you before turning it on.
- When cutting new growth, use a wide sweeping action so that the stems are fed directly into the blade. Allow the blades to reach full speed before cutting.
- When operating, keep the cutting blades away from people and objects such as walls, large stones, trees, vehicles, etc. If the blade stalls, immediately stop the trimmer. Remove the battery pack before attempting to clear jammed debris from the cutting blades.

- Always wear gloves, eye and head protection when cutting. Always cutting with the front hand barrier installed on the product.
- Do not attempt to cut stems that are too thick and soft for the cutting blade.

Top cutting

Use a wide sweeping motion. A slight downward tilt of the cutting blades in the direction of motion gives the best cutting results.

Side cutting

When trimming the sides of the hedge, begin at the bottom and cut upwards, tapering the hedge inward at the top. This shape will expose more of the hedge, resulting in a more uniformed growth.

Maintenance and Service

Maintenance, storage and disposal

- Disconnect the battery pack from the machine before carrying out maintenance or cleaning work.
- When not in use store the machine out of the reach of children.
- Use only manufacturer recommended replacement parts and accessories.
- To clean the tool, remove battery pack and use only mild soap and a damp cloth to clean the tool. Do not immerse tool in water or spray with a hose. Do not allow any liquid to get inside it. Do not clean with a pressure washer.
- Inspect and maintain the machine regularly. Have the machine repaired only by an authorized repairer.
- The battery must be removed from the appliance before it is scrapped.
- The battery is to be disposed of safely.

Transport

The contained lithium-ion batteries are subject to the Dangerous Goods Legislation requirements. The batteries are suitable for road-transport by the user without further restrictions.

When shipping by third parties (e.g.: by air transport or for warding agency), special requirements on packaging and labeling must be observed. For preparation of the item being shipped, consulting an expert for hazardous material is required. Dispatch battery packs only when the housing is undamaged. Please also observe the possibility of more detailed national regulations.

Guarantee

Guarantee

Dear Customer,

This equipment is provided with a 2-year guarantee from the date of purchase. In case of defects, you have statutory rights against the seller of the product. These statutory rights are not restricted by our guarantee presented below. Terms of Guarantee the term of the guarantee begins on the date of purchase, please retain the original receipt and it's required as proof of purchase. If a material or manufacturing defect occurs within 2-year of the date of the purchasing, we will repair or replace the product for you free of charge.

This guarantee requires the defective equipment and proof of purchase to be presented within the 2-year period with a brief written description of what constitutes the defect and when it occurred. If the defect is covered by our guarantee, you will receive either the repaired product or a new product. No new guarantee period begins on repair or replacement of the product.

Guarantee Period And Statutory Claims For Defects

The guarantee period is not extended by the guarantee service. This also applies for replaced or repaired parts. Any damages and defects already present at the time of purchase must be reported immediately after unpacking.