

OREIN

Smart LED Security Light With Single Head

MODEL: OL1900156

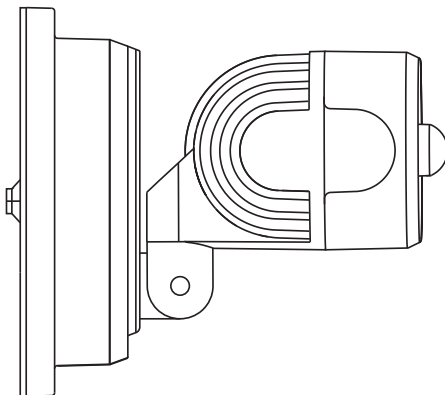

Please read these instructions thoroughly prior to installation, then store in a safe place for future reference.

For the App control instruction, please refer to page 22-24.



Scan the brand code to
get the instruction videos
of how to use

PRODUCT SPECIFICATION

SPECIFICATIONS	SPECIFICATIONS
Wattage: 5.5W	Distance Lighting: 6.5ft-20ft
Lumens: 720LM	Lighting Time: 30S
Voltage: AC 100-240V, 50/60HZ	Installation Height: 5.9ft-8.2ft

PARTS LIST



NOTE: Hardware shown to actual size.

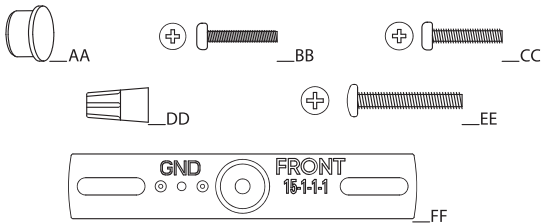

Part	Description	Quantity
AA	Rubber plug	1
BB	Mounting bracket screw	2
CC	Mounting bracket screw	2
DD	Wire nut	2
EE	Mounting bolt	2
FF	Mounting bracket (not to scale)	1

We appreciate the trust and confidence you have placed in OREiN through the purchase of flood light. We strive to continually create quality products designed to enhance your home. Visit us online to see our full line of products available for your home improvement needs.

Thank you for choosing OREiN. ♥

FUNCTION DESCRIPTION

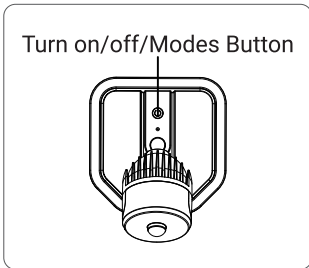







1. Press 1S to turn on and press 2S long to turn off. The light has a mode memory function.
2. Click the button(1S) to cycle through the following 2 modes.

2.1 Motion Mode (100% brightness fast flash twice) : The light will turn on after detecting the motion in night and delay 30s to be auto off, keeping off when detecting no motion.

2.2 Light Mode (30% brightness breath once) : The light is fixed always on and controlled by manual switch, with no sensing function.

3. After connecting the APP, it will have the 3rd security mode. It is mainly a deterrent to those intruding thieves and animals. When motion is detected, the light will trigger a red and white fast flashing light to alarm.

TOOLS REQUIRED (not included)

		
Flathead Screwdriver	Screwdriver	Silicone Sealant
		
Step Ladder	Eye Protection	Pliers

Note:

1. At an ambient temperature of 77 degrees fahrenheit, rh 30%-80% the detection distance is at max. (up to 20ft.). As the temperature increases or decreases, the detection distance will be affected.
2. To reduce possible nuisances, do not mount the fixture near a heat source like an air conditioner, vent or furnace exhaust, or in a direction facing any reflective object or other nearby light source.
3. No any reflective object can be allowed within 1.5m radius of the sensor head, otherwise, it will cause flashing lights.

SAFETY INFORMATION

Please read and understand this entire manual before attempting to assemble, operate or install the product.

PRODUCT MUST BE INSTALLED BY A QUALIFIED ELECTRICIAN !

WARNING

1. Shut off power at the circuit breaker or fuse panel before

removing the old fixture or installing the new one.

2.LED electronics can be damaged by electrostatic discharge (ESD) shock. Before installation, discharge yourself by touching a grounded bare metal surface to remove this hazard.

3.To avoid damage, do not remove the clear lens over the LED module.

IMPORTANT SAFETY INSTRUCTIONS

1.Turn off the power before installing or servicing.

2.Do NOT touch or install fixture while in contact with standing water.

3.Do NOT remove the protective LED lens.

4.Do NOT look directly at lighted LEDs for any length of time.

5.Do NOT leave bare wires exposed outside the wall canopy enclosure.

6. Electrical requirements: 100-240V, 50/60Hz

7.Suitable for wall or eave mounting onto recessed or round surface mounted electrical boxes rated for wet location. Not suitable for ground mount electrical boxes.

8.Do NOT allow the sensor head to touch the LED head housing. Maintain at least 1 in. spacing between the LED heads and the sensor head.

9.For proper operation and protection against water damage, the motion sensor adjustment controls MUST be faced downward.

10.Do NOT mount below 5 ft.

PREPARATION

Before beginning installation of product, make sure all parts are present. Compare parts with parts list.

If any part is missing or damaged, do not attempt to install the product. Tools Required for Assembly (not included): Phillips

Screwdriver, Flat-head Screwdriver, Step Ladder, Pliers, Silicone Sealant, Eye Protection.

ASSEMBLY INSTRUCTIONS

CAUTION: PRODUCT MUST BE INSTALLED BY A QUALIFIED ELECTRICIAN!

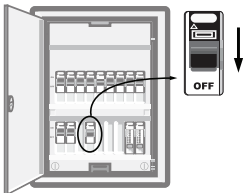

1. Turn off power to work area at main circuit breaker or fuse box.

CAUTION: Do not rely on wallswitch to turn off power.

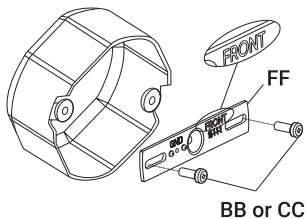

2. Install the mounting bracket (FF) with the stamped word "FRONT" facing away from the junction box. Use the mounting bracket screws (BB or CC) that best fit the junction box. If necessary, use the screws that were removed from the existing light fixture. Firmly pull on the mounting bracket (FF) to verify it is securely mounted to the junction box.

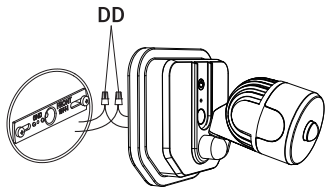

3. Connect the white wire of the fixture to the white wire from the junction box with wire nut(DD). Connect the black wire of the fixture to the black wire from the junction box with wire nut(DD).

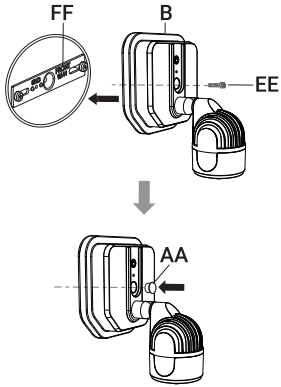

- Align the fixture (B) with the mounting plate (FF). And then tighten the mounting bolt (EE) securely through the center of the mounting plate (FF). Do not over tighten. Push the rubber plug (AA) firmly into the mounting bolt hole on the light fixture (B).

NOTICE: When attaching this light to an external, surface mount junction box, caulk around the inside of the light fixture (B) before attaching to the light fixture (B).

- Caulk around the light fixture

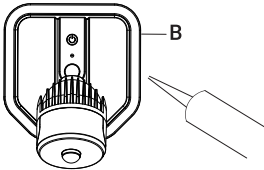

IMPORTANT: Failure to completely caulk around the light fixture base (B) could lead to water damage and is not covered under warranty.

Caulk around the light fixture base (B) and mounting surface with silicone sealant (not included).

ADJUSTING THE SENSOR HEAD

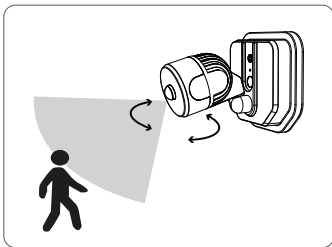

Aim sensor head toward desired detection area and make sure sensor head is positioned with controls facing toward the ground. You can adjust the sensor head up and down, left to right for desired coverage area.

CARE AND MAINTENANCE

Any cleaning or maintenance of the light should be carried out with the source of power turned off. The light shouldn't be cleaned with a damp cloth. Never use any abrasive cleaning products on the lamp heads or motion sensor lens. Never add paint to the light. Do not clean with a high pressure spray or hose pipe. Periodically, check the silicone is still in place and the light is secure on the wall mount.

TROUBLES SHOOTING

PROBLEM	PROBLEM CAUSE	CORRECTIVE ACTION
Light does not come on at night when motion is detected	<ol style="list-style-type: none">1.No power is being delivered to the light.2.Another light source is causing the security light to think it is daylight3.Wiring inside electrical box came loose.	<ol style="list-style-type: none">1.Check that circuit breaker and/or wall switch power is on.2.Turn off surrounding lights or re-aim the sensor head.3.After turn in a power off to the light reconnect any loose wiring.
Security light comes on during the day.	Sensor is in a shaded area and fooled into thinking it is nighttime.	<ol style="list-style-type: none">1.Shine a flashlight onto the light sensor.2.Relocate security light to where allows enough light enter the sensor during daytime.
The Light flashes.	There is lighting, welding, mobile sources or other such unstable light.	Avoid to irradiate by such light source.

CONNECT THE APP

1. Get the AiDot APP from App Store or Google Play.



2. Create an account and sign in.

3. Press ' + ' button to add device.

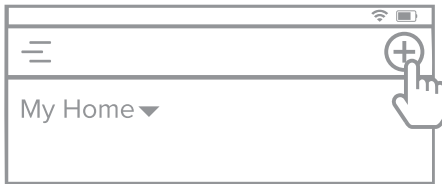

4. Follow the instructions on App.

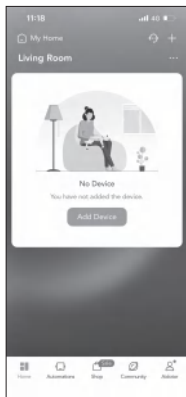

1 Add the device

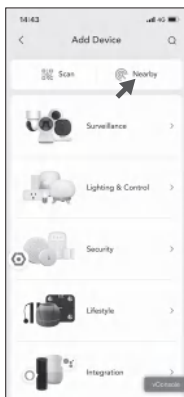

2 Choose the device what you find in 'Nearby'
PS: You must open the Bluetooth and Location Services. If you still can not find the device in 'Nearby', Try to reset the device: Long press the button for more than 10S to enter flash mode.

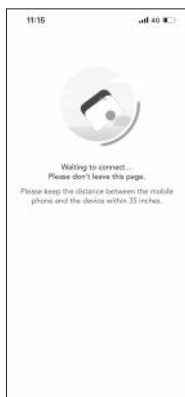

3 Waiting to connect

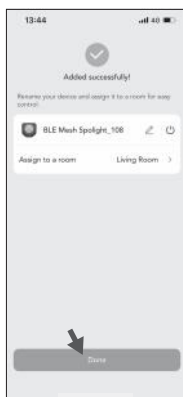



4 Added Successfully

Contact us

SYVIO TECHNOLOGY.CO.,LIMITED
Room A, 8/F,Kwok Cheung Building,
635-637 Shanghai Street, Mong Kok,
Hong Kong
Phone: 1-844-506-1530
Website: www.ioerein.com
Email: Support@ioerein.com

Follow us on social media

 Facebook: [@orein.led](https://www.facebook.com/orein.led)
 Youtube: [OREiN LED](https://www.youtube.com/OREiN LED)

Made in China



Scan the brand code to
get the instruction videos
of how to use

V1.0

