

ORÉIN

LED Security Lights with Motion Sensor

26W, 3500LM

MODEL: OL3600330

SKU: OL36003-WW-US

ID: OL36003-WW-US-A02

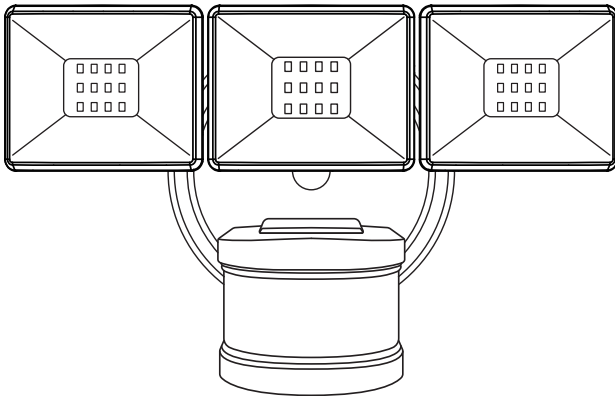

Please read these instructions thoroughly prior to installation, then store in a safe place for future reference.

Table of Contents

Table of Contents	1	Package Contents	3
Safety Information	1	Installation	4
Pre-Installation	2	Operation.....	6
Prepare for Installation	2	Care and Cleaning	9
Specifications	2	Troubleshooting	10
Tools Required	2		
Hardware Included	3		

Safety Information

PRECAUTIONS

- Please read and understand this entire manual before attempting to assemble, install, or operate this light fixture.
- This light fixture requires a 120-Volt AC power source.
- Some codes require installation by a qualified electrician.
- This light fixture should be installed outdoors to a wall or eave.
- The light fixture should be mounted approximately 8 ft. (2.4 m) above the ground. If the light fixture is mounted higher than recommended, aiming the sensor down will reduce the coverage area. .



WARNING: Turn the power off at the circuit breaker or fuse. Place tape over the circuit breaker switch and verify power is off at the light fixture.



WARNING: Risk of fire. Keep the lamp heads at least 2 in. (51 mm) from combustible materials.



CAUTION: Burn hazard. Allow the light fixture to cool before touching.

NOTICE: Do not connect this light fixture to a dimmer switch or timer.

NOTICE: Any changes or modifications to this unit not expressly approved by the party responsible for compliance could void the user's authority to operate the equipment.

NOTICE: This equipment has been tested and found to comply with the limits for a Class B digital device, pursuant to part 15 of the FCC Rules. These limits are designed to provide reasonable protection against harmful interference in a residential installation. This equipment generates, uses and can radiate radio frequency energy and, if not installed and used in accordance with the instructions, may cause harmful interference to radio communications. However, there is no guarantee that interference will not occur in a particular installation. If this equipment does cause harmful interference to radio or television reception, which can be determined by turning the equipment off and on, the user is encouraged to try to correct the interference by one or more of the following measures:

- Reorient or relocate the receiving antenna.
- Increase the separation between the equipment and receiver.
- Connect the equipment into an outlet on a circuit different from that to which the receiver is connected.
- Consult the dealer or an experienced radio/TV technician for help.

- This device complies with Part 15 of the FCC Rules. Operation is subject to the following two conditions:
 (1) this device may not cause harmful interference, and (2) this device must accept any interference received, including interference that may cause undesired operation.

Pre-Installation

Prepare for Installation

Before installing the light fixture, ensure that all parts are present. Compare parts with the Hardware Included and Package Contents sections. If any part is missing or damaged, do not attempt to assemble, install, or operate this light fixture.

SPECIFICATIONS

Sensing Range	Max 40 ft (various between the different detecting position)
Sensing angle	Up to 240°
Wattage	26 Watts
Lumens	3500lm
Input voltage	120 VAC, 60 Hz
Working Modes	TEST mode, AUTO mode, D2D mode

TOOLS REQUIRED



Phillips screwdriver



1/8 in. Flathead screwdriver

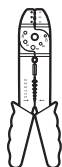

Wire strippers/
cutters



Circuit tester



Work gloves



Silicone sealant



Ladder



Safety goggles

HARDWARE INCLUDED



NOTE: Hardware shown to actual size.

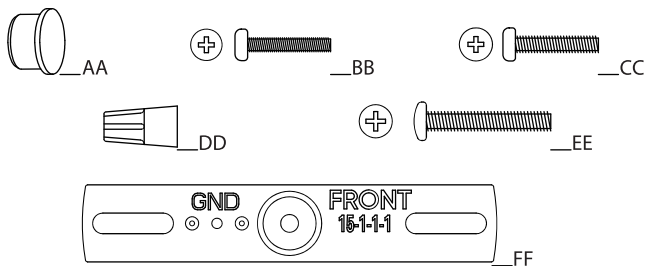

Part	Description	Quantity
AA	Rubber plug	1
BB	Mounting bracket screw	2
CC	Mounting bracket screw	2
DD	Wire nut	2
EE	Mounting bolt	1
FF	Mounting bracket (not to scale)	1

PACKAGE CONTENTS

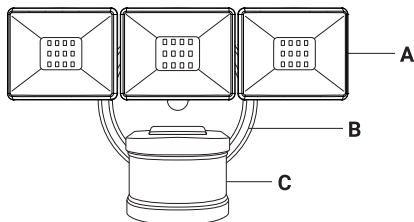

Part	Description	Quantity
A	Lamp head	3
B	light fixture.	1
C	Motion sensor	1

Installation

1. Determine the mounting location

 **NOTE:** The light fixture should be mounted approximately 8 ft. (2.4 m) above the ground. If the light fixture is mounted higher than recommended, aiming the sensor down will reduce the coverage area.

- Determine the mounting location – wall or eave mount.
- Position the lamp heads (A) in the general direction of the desired light coverage.

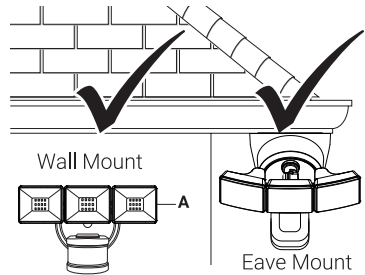

2. Install the mounting bracket

 **WARNING:** Turn the power off at the circuit breaker or fuse. Place tape over the circuit breaker switch and verify power is off at the light fixture.

 **NOTE:** Four mounting bracket screws of various sizes are included. The installation will only require two. Discard the unused mounting bracket screws after installation.

- Remove the existing light fixture.
- Install the mounting bracket (FF) with the stamped word “FRONT” facing away from the junction box. Use the mounting bracket screws (BB or CC) that best fit the junction box. If necessary, use the screws that were removed from the existing light fixture.
- Firmly pull on the mounting bracket (FF) to verify it is securely mounted to the junction box.

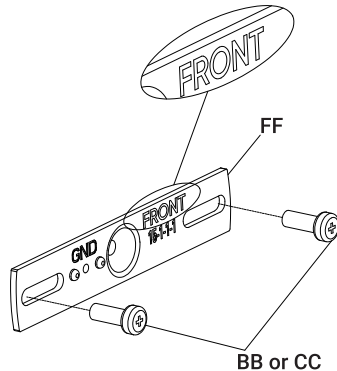

3 .Make the electrical connections

- Connect the white wire of the fixture to the white wire from the junction box with wire nut(DD).
- Connect the black wire of the fixture to the black wire from the junction box with wire nut(DD).

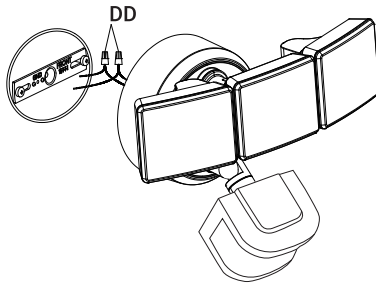

4 .Mount the light fixture

- Align the fixture (B) with the mounting plate (FF). And then tighten the mounting bolt (EE) securely through the center of the mounting plate (FF). Do not over tighten.
- Push the rubber plug (AA) firmly into the mounting bolt hole on the light fixture (B).

NOTICE: When attaching this light to an external, surface mount junction box, caulk around the inside of the light fixture (B) before attaching to the light fixture (B).

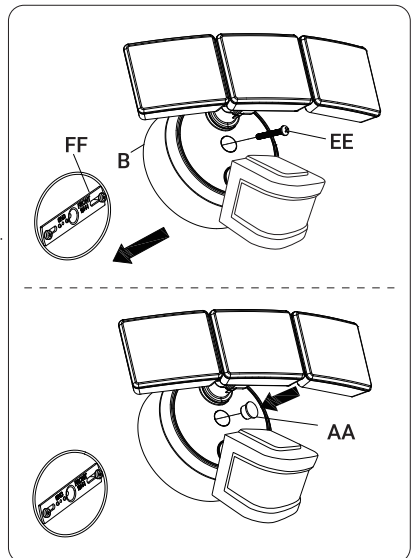

5 .Caulk around the light fixture

IMPORTANT: Failure to completely caulk around the light fixture base (B) could lead to water damage and is not covered under warranty.

- Caulk around the light fixture base (B) and mounting surface with silicone sealant (not included).

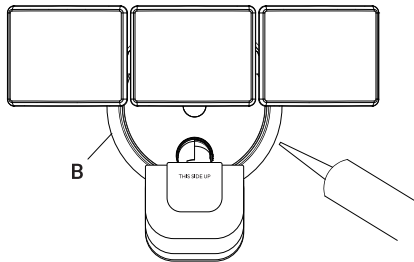

Operation

1 .Adjusting the lamp heads



WARNING: Risk of fire. Keep the lamp heads at least 2 in. (51 mm) from combustible materials.

- Turn the power on at the circuit breaker or fuse and turn on the wall switch.
- If needed, gently grasp the lamp heads (A) and tilt them up or down or side to side to adjust the light coverage area.

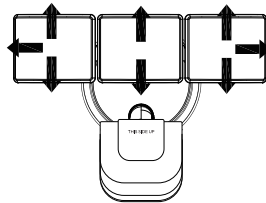

2 .Setting the sensor for testing



NOTE: Note: Slide button to the TEST position, the light will enter the TEST mode. In this mode, the light will light in both day and light for the convenience to test if the light is in good condition before installation.

1. Slide the button to **TEST** position to enter the TEST mode, then give motion or movement to the sensor to turn on the light.
2. Once Detecting the motion, the light will light and keep lighting for 5 seconds before auto off.(Note: In this mode, time and sensor adjustment can't work)

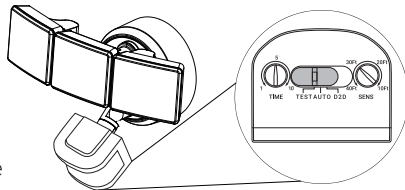

3. Set the Daily Working Mode After Test

- Slide the button to **AUTO** position to enter the AUTO mode

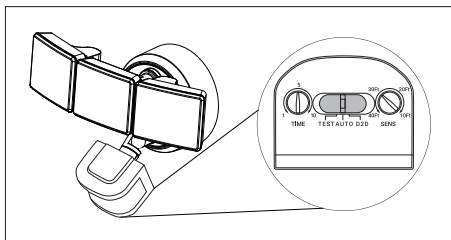

- Slide the button to **D2D** position to enter the D2D mode

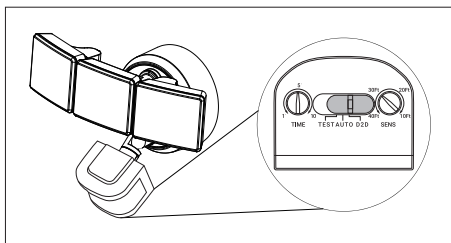

4 .Adjusting the motion sensor detection zone

- Perform a "walk test": walk in an arc across the front of the motion sensor (C).
- Watch the light. The light will come on and the red LED will flash indicating motion has been detected.
- Stop, wait for the light to turn off, and then begin walking again.
- Continue this process until the detection zone has been established.

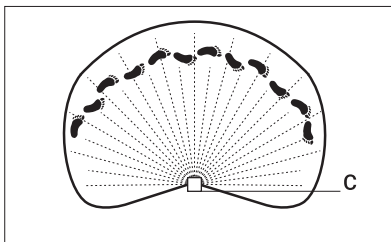

- If needed, gently grasp the motion sensor (C) and move it from side to side or up and down to adjust the detection zone.

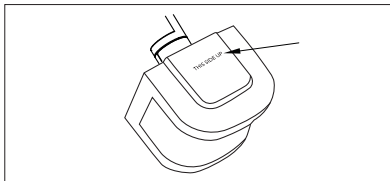

- To ensure the motion sensor work properly, please keep the marking "THIS SIDE UP" on the motion sensor up.

- It's recommended to keep the motion sensor tilt angle within 40° under daily usage.

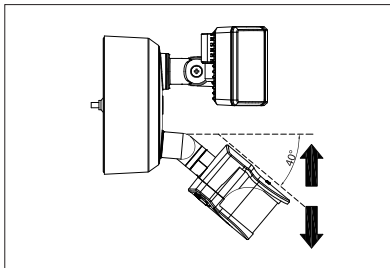

5.Adjusting the SENSITIVITY control

- To increase the sensitivity, turn the "SENS" control counterclockwise.

- To decrease the sensitivity, turn the "SENS" control clockwise.

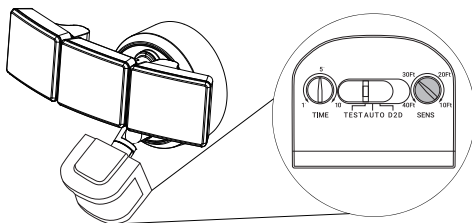

NOTE: The motion sensor (C) is more sensitive to motion when movement is across the front of the sensor. The motion sensor (C) is less sensitive to motion when movement is directly toward the front of the sensor.



NOTE: The higher the "SENSITIVITY" setting, the greater the possibility of false triggering. To reduce false triggering, please choose the sensitivity you need.

6 .Adjust the TIMER control



NOTE: The 'TIMER' button controls the continuous lighting time before auto off when motion is detected. It only work on AUTO Mode, and not work for other TEST and D2D mode.

- **TEST mode:** With TEST mode, you can run to test if the light is in good condition before installation. In this mode, the light can work in both day and night. After power on, the light can be turned on by detected motion, and automatically turned off after 5s lighting time. 5s lighting time is a fixed presetting for test which can't be adjusted by the time knob, but you can adjust its sensing range (max 40ft).
- **Auto mode:** In AUTO mode, the light will only light in night and be auto off in daytime. (night: sensing environment brightness is darker than 20 ± 15 lux; daytime: sensing environment brightness is brighter than 20 ± 15 lux). The light will be turned on by detected motion, and auto off after lighting time. Both the lighting time and sensing distance can be adjusted. Please set the mode first, and then adjust the time and sensing range. The light will only work at night after the lighting time has been selected.
- **D2D mode:** In D 2 D mode, it will become a dusk to dawn light, auto on in dusk and auto off in dawn. In this mode, the motion detection will not work and the light will be always on in the night and always off in the day. 2 knobs need' not be adjusted.

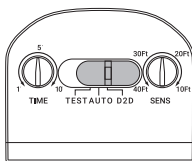
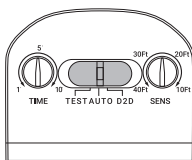
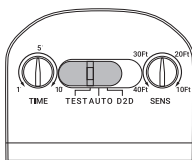

Care and Cleaning

- To prolong the original appearance, clean the light fixture with clear water and a soft, damp cloth only.
- Do not use paints, solvents, or other chemicals on this light fixture. They could cause a premature deterioration of the finish. This is not a defect in the finish and will not be covered by the warranty.
- Do not spray the light fixture with a hose or power washer.

Troubleshooting

Problem	Possible Cause	Solution
The light will not come on.	The light switch is turned off.	Turn the light switch on.
	The fuse is blown or the circuit breaker is turned off.	Replace the fuse or turn the circuit breaker on.
	Daylight turn-off (photocell) is in effect.	Recheck after dark.
	The circuit wiring is incorrect (if this is a new installation).	Verify the wiring is correct.
	The motion sensor is aimed in the wrong direction.	Re-aim the motion sensor to cover the desired area.
The light comes on during the day.	The motion sensor may be installed in a relatively dark location.	The light fixture is operating normally under these circumstances.
	The control is in the "Test" position.	Set the control to "AUTO" or "D2D".
The light comes on for no apparent reason.	The motion sensor may be sensing small animals, automobile traffic, or other heat sources.	Reposition the motion sensor.
	The light fixture is wired through a dimmer or timer.	Do not use a dimmer or timer to control the light fixture. Replace the dimmer or timer with a standard on/off wall switch.
	The motion sensor may be picking up a heat source, such as an air vent, dryer vent, or brightly painted, heat-reflective surface.	Reposition the motion sensor.
The lights stay on continuously.	The light fixture is wired through a dimmer or timer.	Do not use a dimmer or timer to control the light fixture. Replace the dimmer or timer with a standard on/off wall switch.
	The light fixture is on the same circuit as a motor, transformer, or fluorescent bulb.	Install the light fixture on a circuit without motors, transformers, or fluorescent bulbs.
	Heat or light from the bulbs may be turning the motion sensor on and off.	Reposition the lamp heads away from the motion sensor.
The lights flash on and off.	Heat is being reflected from other objects and may be turning the motion sensor on and off.	Reposition the motion sensor.
	The motion sensor is in "TEST" mode and warming up.	While in "TEST" mode, the light only stays on for 5 seconds. Set the control to "AUTO" or "D2D" mode.

Contact us

SYVIO TECHNOLOGY.CO.,LIMITED

Room A, 8/F,Kwok Cheung Building, 635-637 Shanghai

Street, Mong Kok, Hong Kong

Phone: 0086-199-2547-1900

Website: www.iorein.com

Email: Support@iorein.com

Follow us on social media

 Facebook: [@orein.led](https://www.facebook.com/orein.led)

 Youtube: [OREiN LED](https://www.youtube.com/OREiN_LED)

Made in China

