



H13 True HEPA
Air Purifier

User Manual

P100 Mini

READ AND SAVE THESE
INSTRUCTIONS



V1.5

WARRANTY

Welov comes with 1 Year Warranty that begins on the date of purchase.

Welov Corporation warrants all products to be of the highest quality in material, craftsmanship, and service, effective from the date of purchase to the end of the warranty period. The warranty applies to the product and necessary parts and labor relating thereto. The warranty does not apply to damage resulting from failure to follow the operating instructions, accidents, abuse, alterations, or disassembly by unauthorized individuals.

Extend Your Warranty by 1 Year

Register your product at www.welovhome.com/registration to extend your 1-year warranty by an additional year.

Please fill out all required fields and include your order ID, place of purchase, and purchase date, if applicable.

If you have product questions or concerns, don't hesitate to contact us directly at:

support@welovhome.com

Welov has an award-winning warranty, exchange, and customer service program that guarantees hassle-free solutions within 24 hours for any issue you might have with this product!

CONTENTS

IMPORTANT SAFETY INSTRUCTIONS	01
WHAT'S INCLUDED	05
KNOW YOUR AIR PURIFIER	06
Product Overview	06
Control Panel	05
Filtration System	08
SPECIFICATIONS	09
GET STARTED	09
USE YOUR AIR PURIFIER	11
On/Off	11
Sleep Mode	12
Timer	12
Fan Speeds	13
Check Filter Reset	13
Adding Essential Oils	14
MAINTENANCE AND CARE	14
Clean the Air Purifier	15
Replace the HEPA&Activated Carbon Filter	17
Storage	18
TROUBLESHOOTING GUIDE	19

IMPORTANT SAFETY INSTRUCTIONS



Warning

Users should only operate the air purifier once they have understood all the following important safety instructions. Users who have a disability and need assistance are responsible for seeking support and ensuring their own safety in line with the instructions given in this manual.

Moving

* Turn off and unplug the air purifier before moving it.

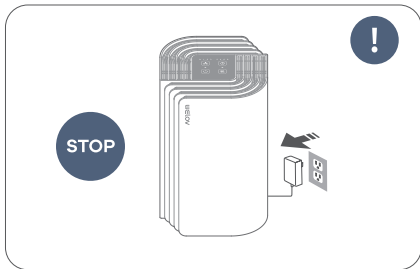

Installation

* Keep a distance of at least **38cm/15inches** between the air inlets and walls or other objects.

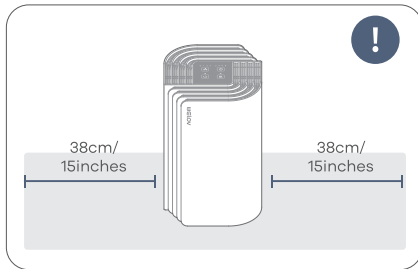

Essential Oils

- * Do not add **essential oils** to the air or filter. The filter will become damaged by the oil and will eventually release an unpleasant smell. Do not use diffusers near the air purifier.

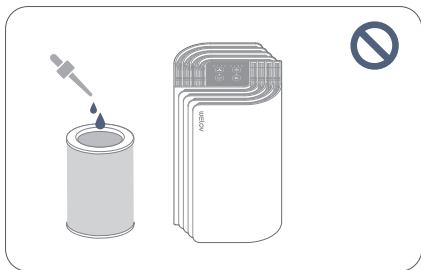

Warning:

- a) During cleaning and maintenance, maybe in risk of risk of fire, electric shock, or injury to persons, and
- b) unplug or disconnect the appliance from the power supply before servicing

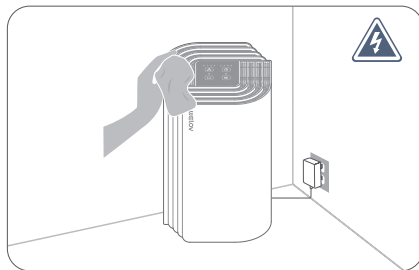

Where in Use

- * Do not put your **fingers** or other objects into the air inlet, air outlet, or filter compartment.

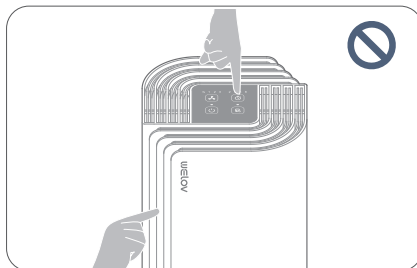

* Keep hair or cloth away from the air purifier to avoid them getting into and **blocking** the inlet/outlet.

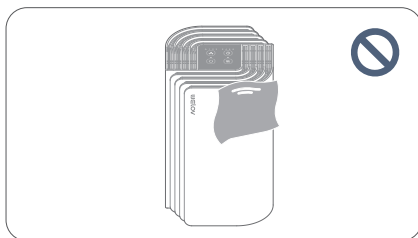

* Please do not sit on, lean on, or tilt the air purifier.

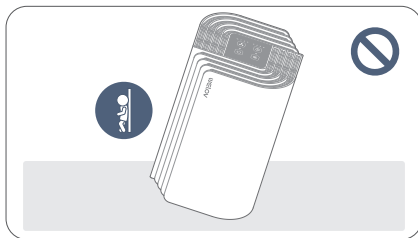

* Always place the air purifier out of the reach of patients, children, or pets.

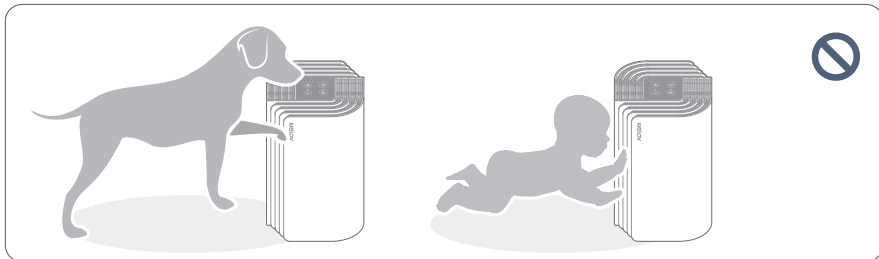

* Please keep your air purifier away from any heat sources, such as stove, oven, electric heater, etc.

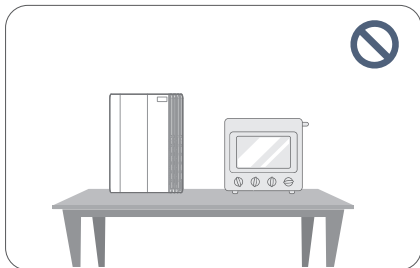

* Children should be supervised to ensure that they do not play with the appliance.

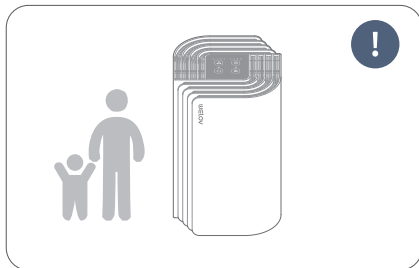

Limitation in Use

* Do not place the air purifier on any uneven surfaces where it can easily fall over.

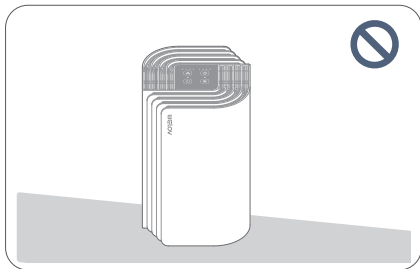

To reduce the risk of fire or electric shock, do not use this air purifier with any solid-state speed control device.

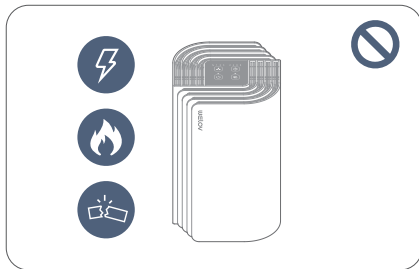

* Do not use the air purifier in **Bathrooms** or other places that are hot or over.

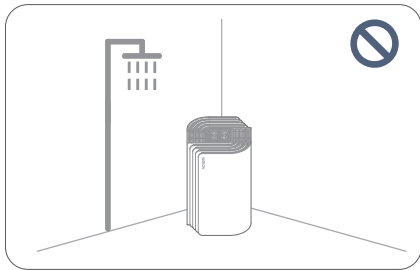

* Do not use your air purifier **Outdoors**. It's for household use only.

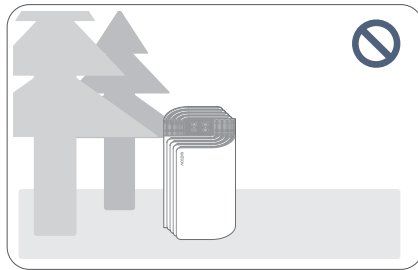

Welov will accept no liability or responsibility for fires or electrical shocks caused by improper operation or not adhering to the above safety instructions.

WHAT'S INCLUDED



P100 Mini
Air Purifier x1



HEPA&Activated
Carbon Filter
(inside) x1



User
Manual x1



Aroma Pad
(inside) x5

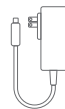

Power Adapter
(inside the
Filter) x1



Quick
Guide x1

KNOW YOUR AIR PURIFIER

PRODUCT OVERVIEW

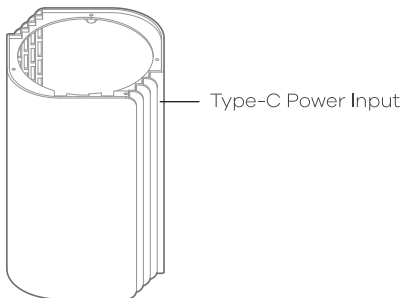
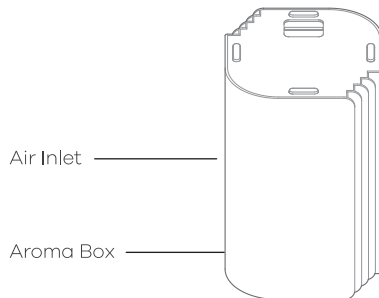
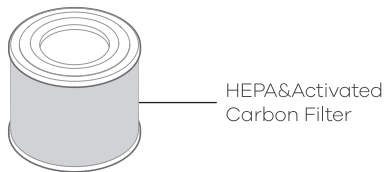
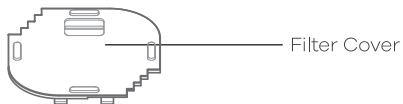
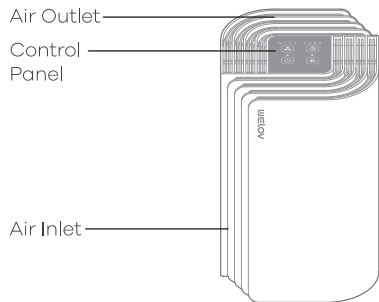

Upside Down

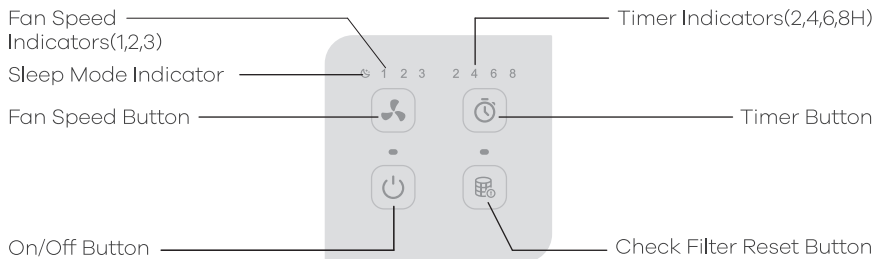

CONTROL PANEL



On/Off Button

* Turns the air purifier on/off.



Sleep Mode

* Turns fan speed button to Sleep Mode on/off.



Speed Buttons

*3 fan speeds options:Low(Indicator 1), medium(Indicator 2), high(Indicator 3)



Timer Button

*Set the time duration to automatically power off the air purifier.



Check Filter Reset Button

*Light up when the air filter should be checked

FILTRATION SYSTEM

The air purifier's filtration system consists of the Pre-Filter, HEPA Filter, Activated Carbon Filter.

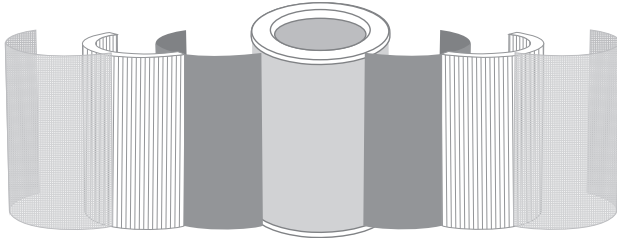

1. Pre-filter

> The pre-filter can filter large particles such as dust, lint, fibers, hair, and pet hair.

2. HEPA Filter

> Filters out particles **0.1 microns** in diameter from at least **99.97%** of the air.

> The HEPA can filter small particles such as smoke, dust, mold spores, bacteria, viruses, and allergens such as pollen, pet dander, and dust mites.

3. Activated Carbon Filter

> This layer is to deal with odors or smoke.

> This layer can also filter the organic compound such as **Formaldehyde, Ammonia, Hydrogen Sulfide, and Volatile Organic Compound(VOCs)**.

• Temperature Conditions for Using the Filter

> Excessive moisture may damage the filter. The air purifier should be used in an area with a humidity level below 85% RH. If you use the air purifier in excessively humid areas, the surface of the filter part will become moldy.

SPECIFICATIONS

Model	P100 Mini
Voltage Input	DC 12V, 1A
Rated Power	9W
Standby Power	< 1W
Dimension	160*160*250mm/6.3*6.3*9.8inch
Net Weight	1.3kg/45.8OZ
CADR	41CFM/70m ³ /h
Noise	23-45dB

GET STARTED

Step 1:

Flip over the air purifier and open the filter cover.

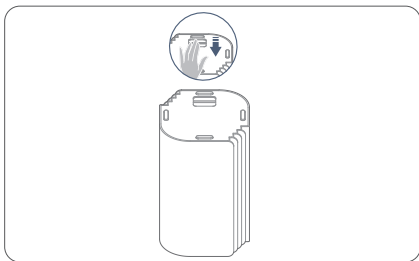

Step 2:

Remove the filter and **Power Adapter** from its plastic packaging and place the filter back into the air purifier.

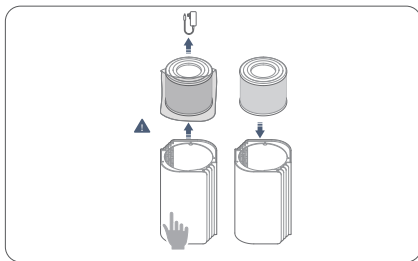

Step 3:

Close the filter cover, and turn over the air purifier to get it ready for use.

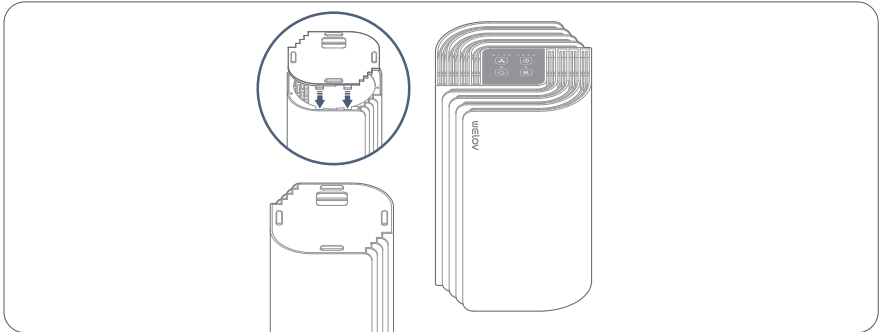

Step 4:

Place the air purifier in a ventilated area and on a level surface. Keep the air outlet facing upwards and maintain a distance of at least **38 cm/15 inches** away from the wall or other objects.

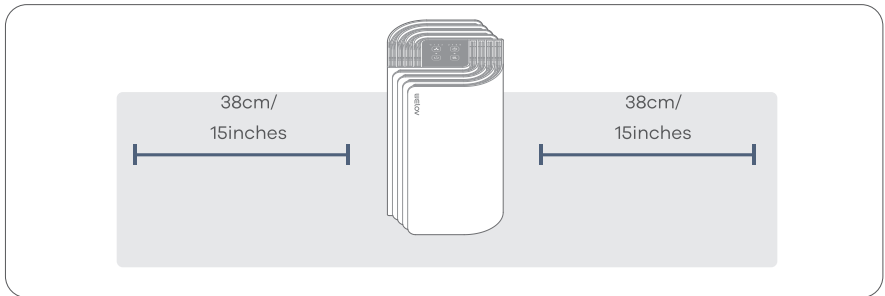

Step 5:

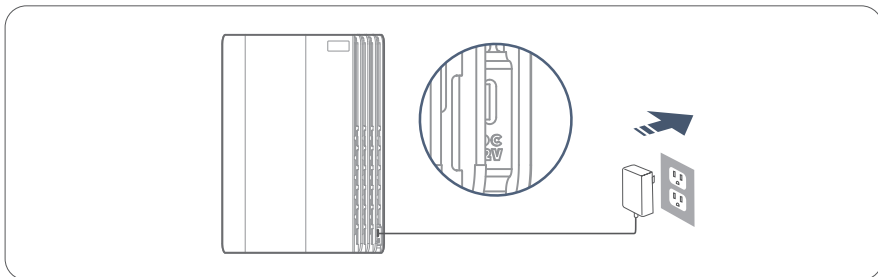

Connect the Type-C end of the Power Adapter to the power input port on the air purifier, and plug the Power Adapter into a working outlet.



USE YOUR AIR PURIFIER

⏻ ON/OFF







- ① After connecting the air purifier to power, press  to turn it on, and it will start purifying the air with the default fan speed.
- ② Tap  again to turn off the air purifier.

Sleep Mode



Sleep Mode operates quietly by using a fan speed lower than low speed.

- ① When the air purifier is working, press  to enter the . All the lights will be off, and the air purifier will continue to work with the lowest fan speed.
- ② Press  again to exit the , and the air purifier will return to the I (low)



Tips:

- ① In sleep mode, timer adjustment are available. The corresponding indicator will light up for 3 second when setting and then turn off.
- ② When the display is turned off, tap any button to turn the display back on. If you don't tap another button, the display will turn off again after 3 seconds.

Timer



Four timer options are available, including 2H, 4H, 6H, and 8H.

- ① Tap  once at a time to select a timer. The corresponding indicator will light up.
- ② Tap  the fifth time or Tap and hold  for 1.5s to disable the timer function.

1.5S

Tips:

- You can change the fan speed at any time while the timer is on.
- The timer will restart if the time is changed.
- The timer will count down from your selected time. When the timer is finished, the air purifier will turn off.

Fan Speeds



- ① There are three speed options for this air purifier, 1 (low), 2 (medium), and 3 (high).
- ② Tap  to cycle fan speed options, and the corresponding fan speed indicator will light up.

Tips:

- The fan speed indicators are not the buttons to adjust the speed.
- The fan speed option of  is the highest level that can purify the air quickly, but it will make louder sounds.
- To effectively purify the air, please close your windows and doors while the air purifier is working. But do ventilate if you are using some combustion equipment, e.g., fireplace or barbecue oven; this is to keep you safe from carbon monoxide.

Check Filter Reset



- When the filter is at the end of its service life, the indicator has been flashing to remind you to replace the filter with a new one.
- ① 1. Reset the service time of the new filter after replacement. Please long press  for 3 seconds until the indicator normally on.

Tips:

In standby mode, the indicator is still on after the set time is reached

Adding Essential Oils

- ① Push in the aroma box and pull it out.
- ② Add 5-7 drops of essential oil to the aroma pad.
- ③ Place the aroma box back into the air purifier.

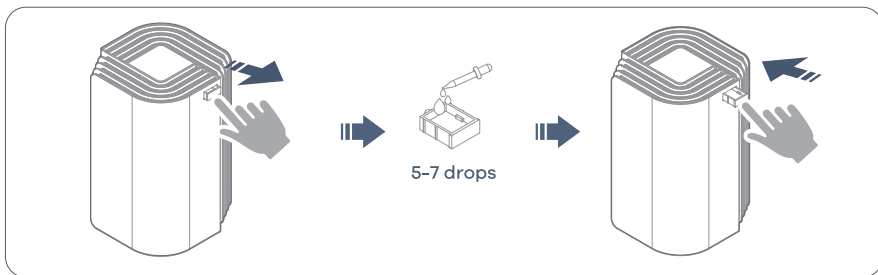

Tips:

Do not mix essential oil blends. Clean the aroma pad and box before using a new essential oil blend

MAINTENANCE AND CARE

Filter Frequency	Cleaning Frequency	Replacing
Pre-filter	Every 2-4 weeks	/
HEPA&Activated Carbon Filter	/	3-6 months

CLEAN THE AIR PURIFIER

Step 1:

Unplug the air purifier before cleaning.

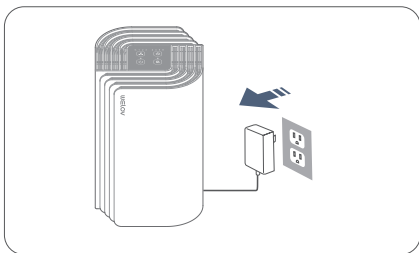

Step 2:

Wipe clean the air purifier's housing with a soft, dry cloth or brush. If necessary, wipe clean the housing with a damp cloth and dry it immediately.



Step 3:

Turn over the air purifier, open the filter compartment cover, then take out HEPA&Activated Carbon Filter.

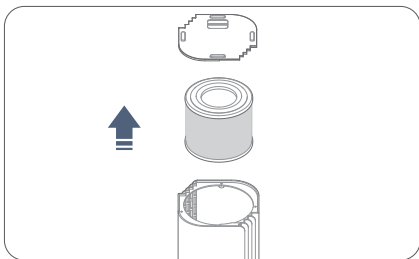

Step 4:

Vacuum inside the filter compartment.

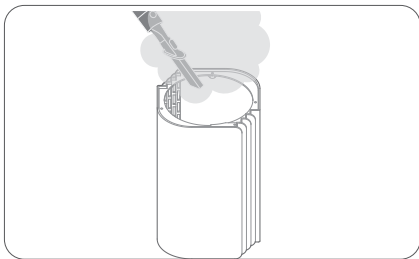

Step 5:

Vacuum the pre-filter, or wipe them with a damp cloth and make them dry completely.

**Step 6:**

Reinstall the HEPA&Activated Carbon Filter into the air purifier, then close the cover.

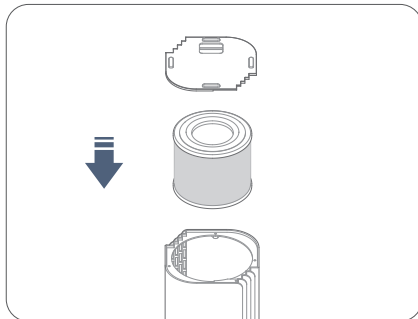
**Notes:**

- If the pre-filter is not cleaned sufficiently, gently wash them under the water with a soft brush. DO NOT reinstall them into the air purifier before it's dry completely.
- Do not clean any parts with abrasive chemicals or flammable agents.
- Do not wash the HEPA&Activated Carbon Filter, as this may damage it.

REPLACE THE HEPA&ACTIVATED CARBON FILTER

- > Generally, the HEPA&Activated Carbon Filter should be replaced every 3-6 months. If the air purifier is frequently used in an environment with relatively high pollution, you will need to replace the HEPA&Activated Carbon Filter more often.
- > The indicator  will light up in white to remind you to replace the **HEPA&Activated Carbon Filter**.
- > You may need to replace the HEPA&Activated Carbon Filter if you notice:
 - * increased noise when the air purifier is turned on;
 - * decreased airflow from the air outlet;
 - * unpleasant odor from the air outlet;
 - * The filter is obviously clogged or too dirty.

Tips:

- To maintain the air purifier's optimal performance, please use the original filter made by Welov. Please contact us to get the purchase link.
- Do not forget to reset the service time of the filter after replacing it.

STORAGE

If the air purifier is not used for an extended period of time, please cover the air purifier and filters with protective plastic bags, then store them in a dry place.

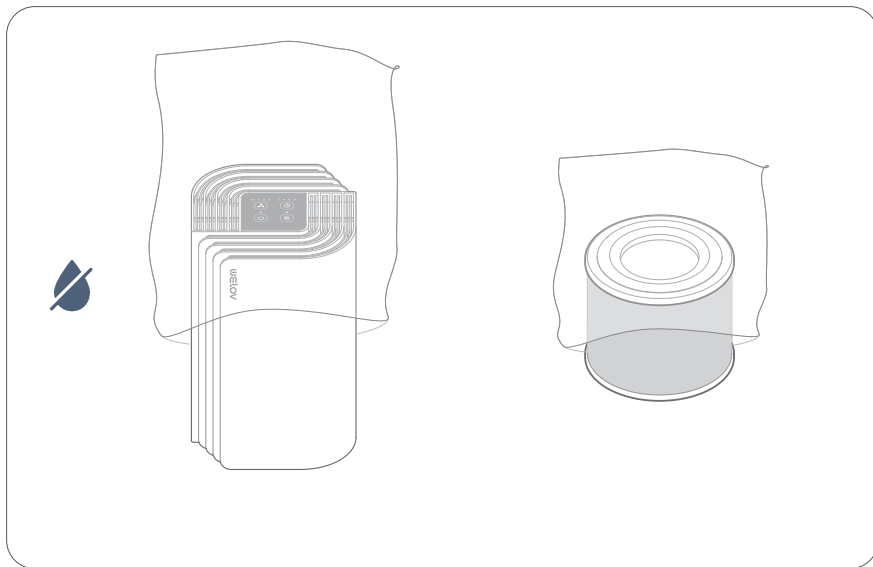

TROUBLESHOOTING GUIDE

If you need any further assistance, please feel free to contact us. To maintain the air purifier's optimal performance, please regularly clean the air purifier and remove objects that block the air inlet.

Problem	Possible Solution
Q1. The air purifier produces an unusual noise after it's turned on.	* Make sure the plastic bag is removed from the HEPA&Activated Carbon Filter and properly installed.
	* Make sure the air purifier is working on a hard, flat, and even surface.
	* The air purifier may be damaged, or there may have foreign objects inside. Please stop using the air purifier and contact us. Do not attempt to repair the air purifier yourself.
Q2. An unpleasant odor is coming from the air purifier.	* Clean the pre-filter, or replace the HEPA&Activated Carbon Filter if necessary.
	* Stop using the air purifier and contact us.
Q3. The air purifier can't be turned on or stops working.	* Check if the air purifier is plugged in.
	* Check if the power cord is damaged. If yes, stop using the air purifier and contact us.

<p>Q3. The air purifier can't be turned on or stops working.</p>	<p>* Try to plug the air purifier into a different outlet.</p>
<p>Q4. The air quality is still poor after using the air purifier.</p>	<p>* The air purifier is malfunctioning. Please contact us.</p>
	<p>* Make sure the is plastic bag removed from the HEPA&Activated Carbon Filter and properly installed.</p>
	<p>* Tap  to adjust the fan speed to a higher level.</p>
	<p>* Close the doors and windows while using the air purifier.</p>
	<p>* Please make sure the air inlet and air outlet of the air purifier are not blocked by any objects. Leave 38 cm/15 inches of clearance on all sides of the air purifier.</p>
	<p>* Please check if the pre-filter is clogged by some large particles, such as hair or lint. If yes, please clean the pre-filter.</p>
	<p>* Replace the HEPA&Activated Carbon Filter.</p>

<p>Q5. The Check Filter Reset Indicator is still on after I replace the HEPA&Activated Carbon Filter with a new one.</p>	<p>* After replacing the filter, please long press  for 3s until the indicator flashes 3 times to reset the service time.</p>
<p>Q6. The HEPA&Activated Carbon Filter is still off after I use the air purifier for 6 months, or it lights up less than 3 months after use.</p>	<p>* The indicator is to remind you to check the HEPA&Activated Carbon Filter. It lights up depending on the use frequency of the air purifier and the air quality. If you don't use your air purifier often, it will take longer to light up. If you use it frequently, it will take shorter to light up.</p>
<p>Q7. The touch panel isn't working.</p>	<p>* Ensure the Child Safety Lock is turned off.</p>
	<p>* The air purifier is malfunctioning. Please contact us.</p>
<p>Q8. Where to buy HEPA&Carbon Activated Filters ?</p>	<p>* Please contact us to get the purchase link, Thanks.</p>

If your problem is not listed, please contact **Customer Support**.

FCC SDOC

It's herewith confirmed to comply with the requirements of FCC Part 15 Rules. Operation is subject to the following two conditions:

- (1) This device may not cause harmful interference, and
- (2) This device must accept any interference received, including interference that may cause undesired operation.

It is understood that each unit marketed is identical to the device as tested, and any changes to the device that could adversely affect the emission characteristics will require retest.

FCC Warning

This device complies with part 15 of the FCC Rules. Operation is subject to the following two conditions: (1) This device may not cause harmful interference, and (2) this device must accept any interference received, including interference that may cause undesired operation.

Warning: Changes or modifications to this unit not expressly approved by the party responsible for compliance could void the user's authority to operate the equipment.

NOTE: This equipment has been tested and found to comply with the limits for a Class B digital device, pursuant to part 15 of the FCC Rules. These limits are designed to provide reasonable protection against harmful interference in a residential installation. This equipment generates, uses and can radiate radio frequency energy and, if not installed and used in accordance with the instructions, may cause harmful interference to radio communications. However, there is no guarantee that interference will not occur in a particular installation. If this equipment does cause harmful interference to radio or television reception, which can be determined by turning the equipment off and on, the user is encouraged to try to correct the interference by one or more of the following measures:

- Reorient or relocate the receiving antenna.
- Increase the separation between the equipment and receiver.
- Connect the equipment into an outlet on a circuit different from that to which the receiver is connected.
- Consult the dealer or an experienced radio/TV technician for help.



CUSTOMER SUPPORT

support@welovhome.com

www.welovhome.com