



Register your product  
to stay tuned with the  
latest information.

---

Register now to get  
**Extra 1 year warranty.**



[Click here](#)





H13 TRUE HEPA AIR  
PURIFIER

# User Manual

## P100

READ AND SAVE THESE  
INSTRUCTIONS



V1.7

## WARRANTY

Welov comes with 1 Year Warranty that begins on the date of purchase.

Welov Corporation warrants all products to be of the highest quality in material, craftsmanship, and service, effective from the date of purchase to the end of the warranty period. The warranty applies to the product and necessary parts and labor relating thereto. The warranty does not apply to damage resulting from failure to follow the operating instructions, accidents, abuse, alterations, or disassembly by unauthorized individuals.

## Extend Your Warranty by 1 Year

Register your product at [www.welovhome.com/registration](http://www.welovhome.com/registration) to extend your 1-year warranty by an additional year.

Please fill out all required fields and include your order ID, place of purchase, and purchase date, if applicable.

If you have product questions or concerns, don't hesitate to contact us directly at:

[support@welovhome.com](mailto:support@welovhome.com)

Welov has an award-winning warranty, exchange, and customer service program that guarantees hassle-free solutions within 24 hours for any issue you might have with this product!

# CONTENTS

<b>IMPORTANT SAFETY INSTRUCTIONS</b>	01
<b>WHAT'S INCLUDED</b>	04
<b>KNOW YOUR AIR PURIFIER</b>	04
Product Overview	04
Control Panel	05
Filtration System	06
<b>SPECIFICATIONS</b>	06
<b>GET STARTED</b>	07
<b>USE YOUR AIR PURIFIER</b>	08
On/Off	08
Night Light	09
Sleep Mode	09
Timer	09
Fan Speeds	10
Child Lock	10
Check Filter Reset	11
<b>MAINTENANCE AND CARE</b>	11
Clean the Air Purifier	11
Replace the HEPA&Activated Carbon Filter	13
Storage	13
<b>TROUBLESHOOTING GUIDE</b>	14

# IMPORTANT SAFETY INSTRUCTIONS



## Warning

Users should only operate the air purifier once they have understood all the following important safety instructions. Users who have a disability and need assistance are responsible for seeking support and ensuring their own safety in line with the instructions given in this manual.

## Moving

\* Turn off and unplug the air purifier before moving it.



## Installation

\* Keep a distance of at least **38cm/ 15inches** between the air inlets and walls or other objects.

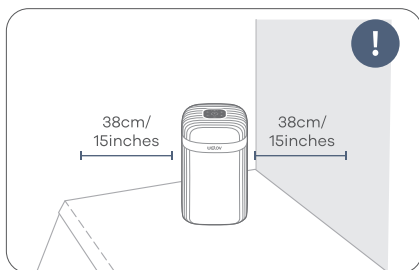

## Essential Oils

\* Do not add **essential oils** to the air purifier or filter. The filter will become damaged by the oil and will eventually release an unpleasant smell. Do not use diffusers near the air purifier.

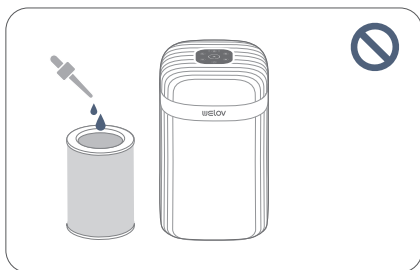

## Warning:

a) During cleaning and maintenance, maybe in risk of risk of fire, electric shock, or injury to persons, and  
b) unplug or disconnect the appliance from the power supply before servicing

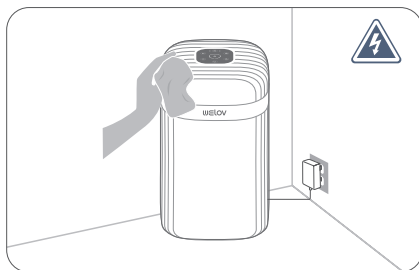

## Where in Use

\* Do not put your **fingers** or other objects into the air inlet, air outlet, or filter compartment.



\* Keep hair or cloth away from the air purifier to avoid them getting into and **blocking** the inlet/outlet.

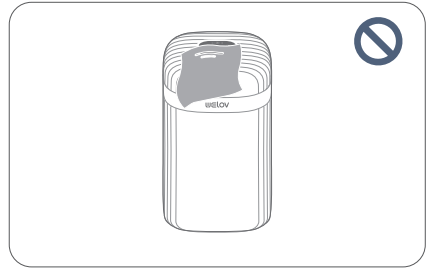

\* Please do not sit on, lean on, or tilt the air purifier.



\* Always place the air purifier out of the reach of patients, children, or pets.

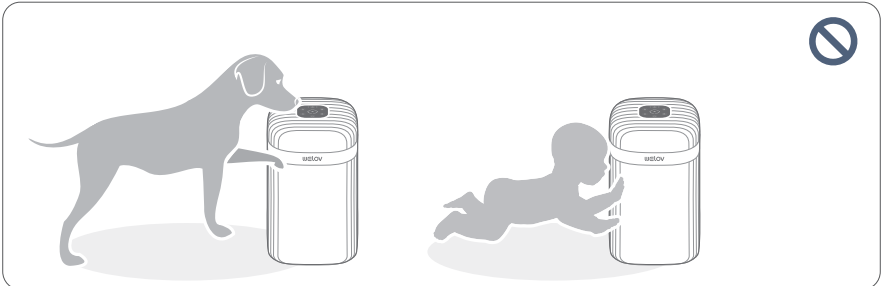

\* Please keep your air purifier away from any heat sources, such as stove, oven, electric heater, etc.

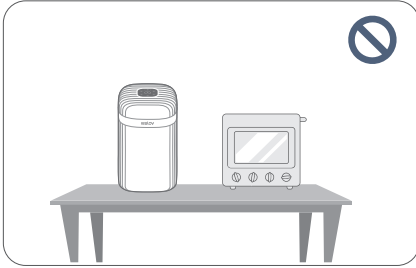

\* Children should be supervised to ensure that they do not play with the appliance.

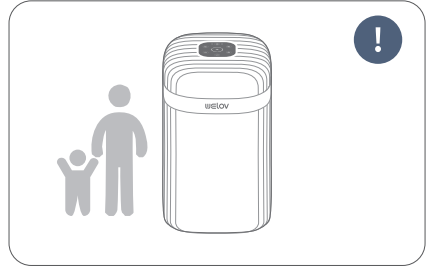

\* do not place the air purifier on any uneven surfaces where it can easily fall over.

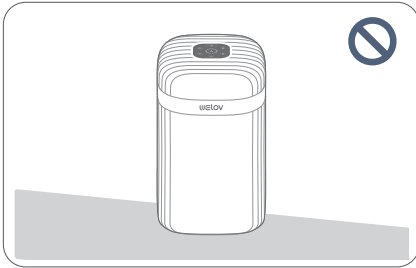

To reduce the risk of fire or electric shock, do not use this air purifier with any solid-state speed control device.

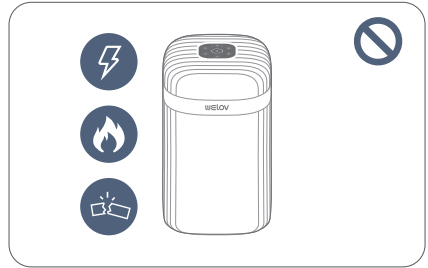

\* do not use the air purifier in **Bathrooms** or other places that are hot or over.

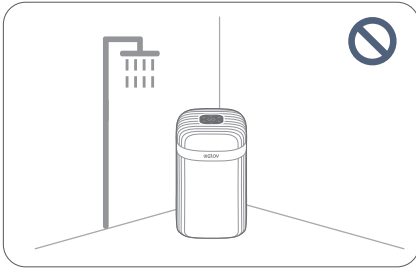

\* do not use your air purifier **Outdoors**. It's for household use only.

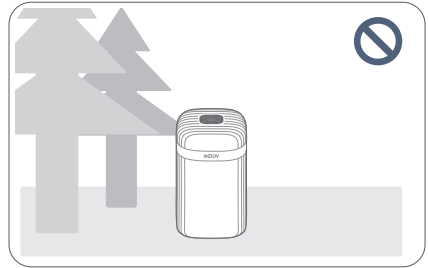

**Welov** will accept no liability or responsibility for fires or electrical shocks caused by improper operation or not adhering to the above safety instructions.

# WHAT'S INCLUDED

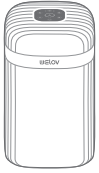

Air purifier x1

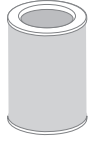

HEPA&Activated  
Carbon Filtrr  
(inside the air purifier) x1



User  
Manual x1

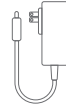

Power Adapter  
(inside the Filter ) x1



Quick  
Guide x1

# KNOW YOUR AIR PURIFIER

## PRODUCT OVERVIEW

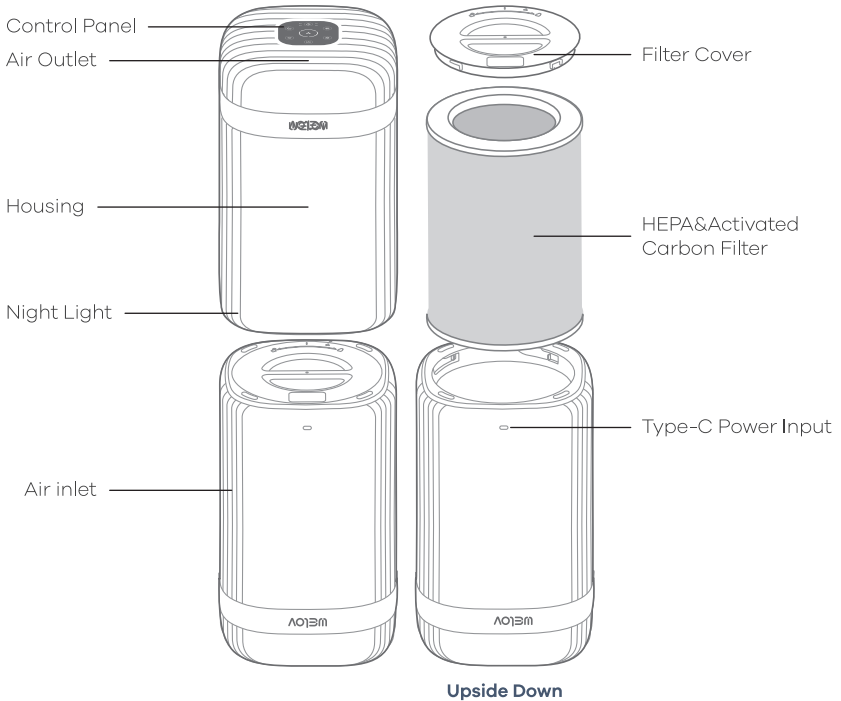



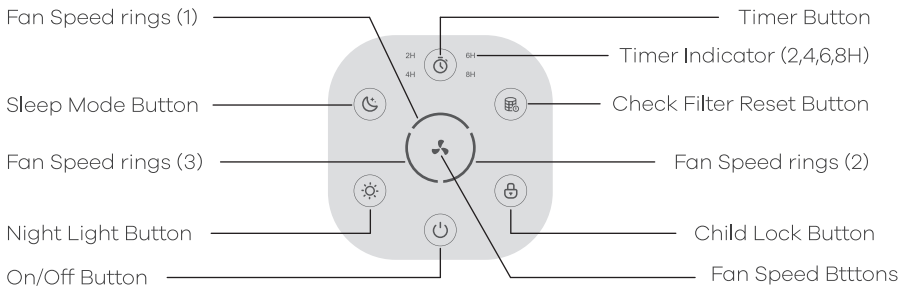

## CONTROL PANEL



### On/Off Button

\* Turns the air purifier on/off.



### Night Light Button

\* Turns Night Light on/off and adjust the brightness.



### Sleep Mode Button

\* Turns Sleep Mode on/off.



### Timer Button

\* Set the time duration to automatically power off the air purifier.



### Check Filter Reset Button

\* Light up when the air filter should be checked.



### Child Lock Button

\* Prevent the current settings from being changed accidentally by children or pets.



### Fan Speed Buttons

\* 3 fan speeds options:



Low(Indicator 1),



Medium(Indicator 2),



High(Indicator 3).

## FILTRATION SYSTEM

The air purifier's filtration system consists of the Pre-Filter, HEPA Filter, Activated Carbon Filter.

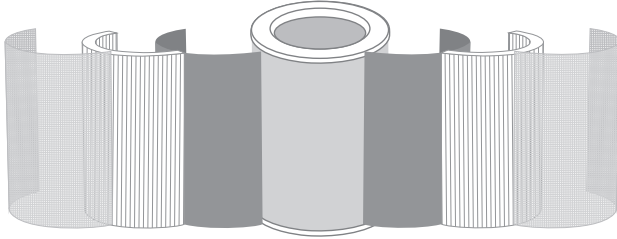

### 1. Pre-filter

> The pre-filter can filter large particles such as dust, lint, fibers, hair, and pet hair.

### 2. HEPA Filter

> Filters out particles **0.1 microns** in diameter from at least **99.7%** of the air.

> The HEPA can filter small particles such as smoke, dust, mold spores, bacteria, viruses, and allergens such as pollen, pet dander, and dust mites.

### 3. Activated Carbon Filter

> This layer is to deal with odors or smoke.

> This layer can also filter the organic compound such as Formaldehyde, Ammonia, Hydrogen Sulfide, and Volatile Organic Compound (VOCs).

### • Temperature Conditions for Using the Filter

> Excessive moisture may damage the filter. The air purifier should be used in an area with a humidity level below 85% RH. If you use the air purifier in excessively humid areas, the surface of the filter part will become moldy.

## SPECIFICATIONS

Model	P100
Voltage Input	DC 12V,2A
Rated Power	17W
Standby Power	< 1W
Dimension	225*225*380mm/8.85*8.85*14.96inches
Net Weight	3.2kg/112.87OZ
CADR	105CFM/180m <sup>3</sup> /h
Noise	23-50dB

## GET STARTED

### Step 1:

Flip over the air purifier and open the filter cover.

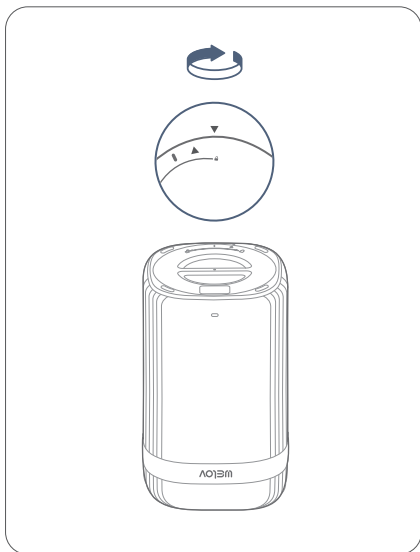

### Step 2:

Remove the filter and **Power Adapter** from its plastic packaging and place the filter back into the air purifier.

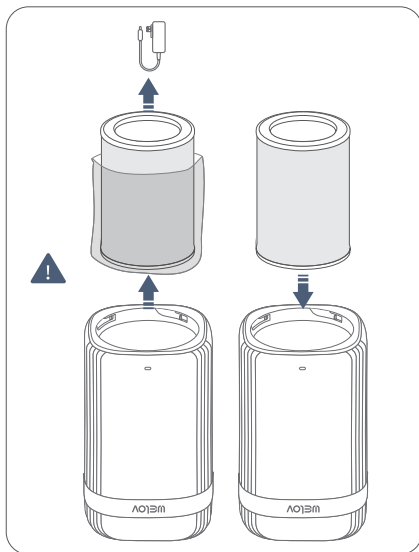

### Step 3:

Close the filter cover, and turn over the air purifier to get it ready for use.

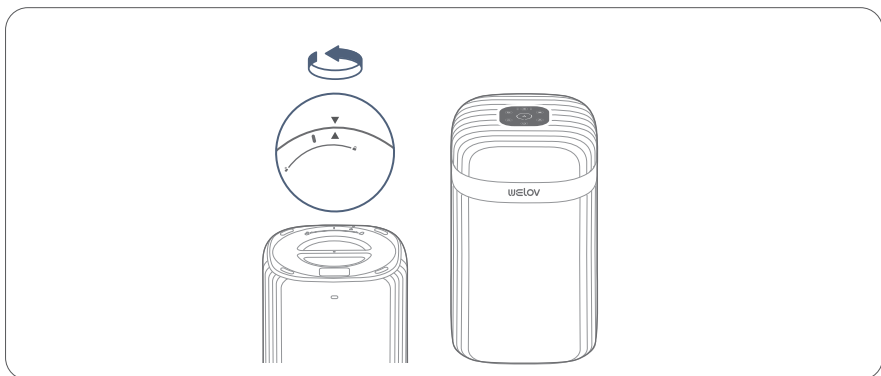

#### Step 4:

Place the air purifier in a ventilated area and on a level surface. Keep the air inlet facing upwards and maintain a distance of at least **38 cm/15 inches** away from the wall or other objects.

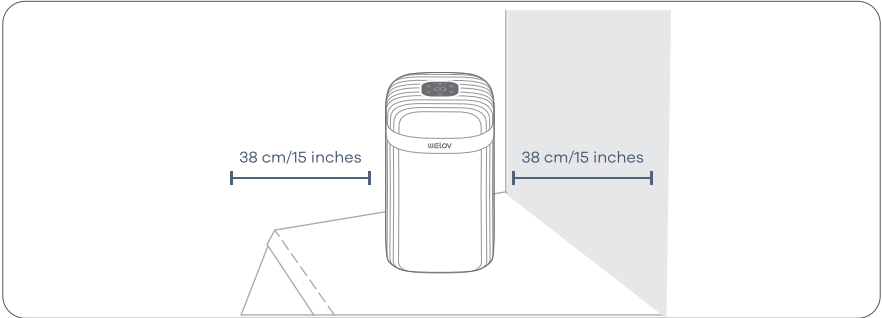

#### Step 5:

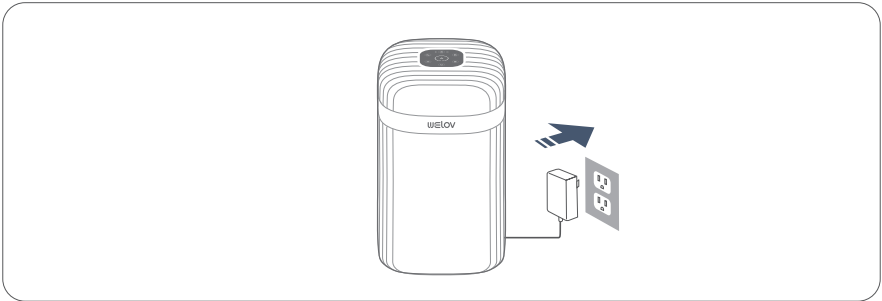

Connect the Type-C end of the Power Adapter to the power input port on the air purifier, and plug the Power Adapter into a working outlet.



## USE YOUR AIR PURIFIER

### ⏻ ON/OFF





- ① After connecting the air purifier to power, press  to turn it on, and it will start purifying the air with the default fan speed.
- ② Tap  again to turn off the air purifier.

## Night Light



This function is to provide illumination for your convenience at night.

- ① Tap  to turn Night Light on/off.
- ② **Tap and hold**  for 1.5s to gradually increase the brightness; release when you get your desired brightness. Tap and hold  it for 1.5s again to decrease the brightness.

### Tips:

The air purifier will remember the brightness of the night light if it's plugged in. The brightness will return to the default level if the air purifier is unplugged and turned on again.

## Sleep Mode



Sleep Mode operates quietly by using a fan speed lower than low speed.

- ① Tap  to turn Sleep Mode on/off.
- ② Sleep Mode will turn off the display after 3 seconds if no other buttons are tapped.



### Tips:

- ① In sleep mode, timer and speeds adjustment are available. The corresponding indicator will light up for 3 second when setting and then turn off.
- ② When the display is turned off, tap any button (except ) to turn the display back on. If you don't tap another button, the display will turn off again after 3 seconds.

## Timer



Four timer options are available, including 2H, 4H, 6H, and 8H.

- ① Tap  once at a time to select a timer. The corresponding indicator will light up.
- ② Tap  until off or **Tap and hold**  for 1.5s to disable the timer function.

### Tips:

- You can change the fan speed at any time while the timer is on.
- The timer will restart if the time is changed.
- The timer will count down from your selected time. When the timer is finished, the air purifier will turn off.

## ⌚ Fan Speeds



- ① There are three speed options for this air purifier, which include ⌚ (low), ⌚ (medium), and ⌚ (high).
- ② Tap ⌚ to cycle fan speed options, and the corresponding fan speed ring will light up.

### Tips:

- The fan speed indicators are not the buttons to adjust the speed.
- The fan speed option of ⌚ is the highest level that can purify the air quickly, but it will make louder sounds.
- To effectively purify the air, please close your windows and doors while the air purifier is working. But do ventilate if you are using some combustion equipment, e.g., fireplace or barbecue oven; this is to keep you safe from carbon monoxide.

## 🔒 Child Lock



When the air purifier is on, you can lock the display to prevent settings from being accidentally changed. Buttons will not respond to being tapped.

- ① Tap and hold 🔒 for 3 seconds to lock the display. The 🔒 indicator will light up in the center of the display.
- ② The 🔒 indicator will blink when any other button is tapped to indicate that Display Lock is on.
- ③ Tap and hold 🔒 again for 3 seconds to unlock the display. The 🔒 indicator will turn off.

### Tips:

Display Lock can still be used when the air purifier is in Standby Mode.

## Check Filter Reset



When the filter is at the end of its service life, the indicator has been flashing to remind you to replace the filter with a new one.

① Reset the service time of the new filter after replacement. Please long press  for 3 seconds until the indicator turns off.

### Tips:

In standby mode, the indicator is still on after the set time is reached.

## MAINTENANCE AND CARE

Filter Frequency	Cleaning Frequency	Replacing
Pre-filter	Every 2-4 weeks	/
HEPA&Activated Carbon Filter	/	3-6 months

## CLEAN THE AIR PURIFIER

### Step 1:

Unplug the air purifier before cleaning.

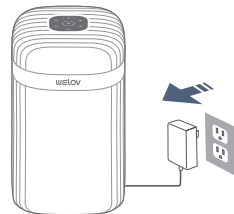

### Step 2:

Wipe clean the air purifier's housing with a soft, dry cloth or brush. If necessary, wipe clean the housing with a damp cloth and dry it immediately.



**Step 3:**

Turn over the air purifier, open the filter cover, then take out HEPA&Activated Carbon Filter.

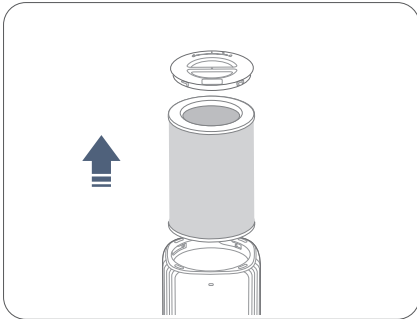
**Step 4:**

Vacuum inside the filter compartment.

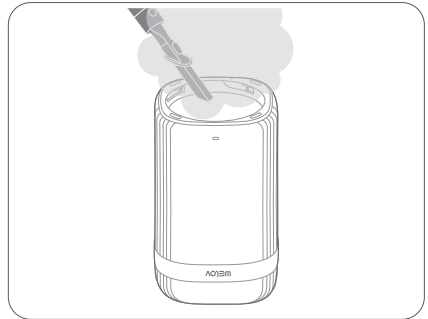
**Step 5:**

Vacuum the pre-filter, or wipe them with a damp cloth and make them dry completely.

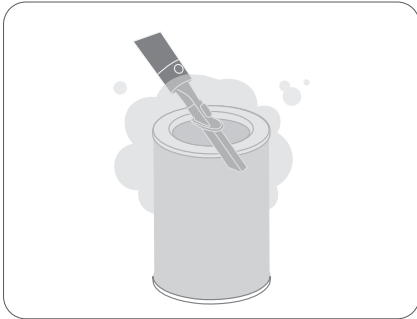
**Step 6:**

Reinstall the HEPA&Activated Carbon Filter into the air purifier, then close the cover.

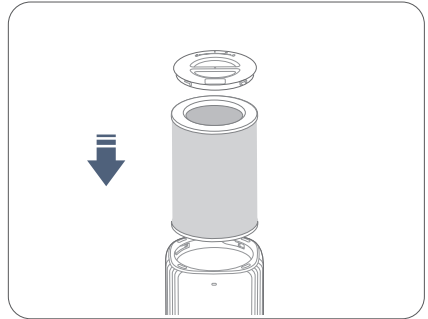
**Notes:**

- If the pre-filter is not cleaned sufficiently, gently wash them under the water with a soft brush. DO NOT reinstall them into the air purifier before it's dry completely.
- Do not clean any parts with abrasive chemicals or flammable agents.
- Do not wash the HEPA&Activated Carbon Filter, as this may damage it.



## REPLACE THE HEPA&ACTIVATED CARBON FILTER

- > Generally, the HEPA&Activated Carbon Filter should be replaced every 3-6 months. If the air purifier is frequently used in an environment with relatively high pollution, you will need to replace the HEPA&Activated Carbon Filter more often.
- > The indicator  will light up in white to remind you to replace the **HEPA&Activated Carbon Filter**.
- > You may need to replace the HEPA&Activated Carbon Filter if you notice:
  - \* increased noise when the air purifier is turned on;
  - \* decreased airflow from the air outlet;
  - \* unpleasant odor from the air outlet;
  - \* The filter is obviously clogged or too dirty.

### Tips:

- To maintain the air purifier's optimal performance, please use the original filter made by Welow. Please contact us to get the purchase link.
- Do not forget to reset the service time of the filter after replacing it.

## STORAGE

If the air purifier is not used for an extended period of time, please cover the air purifier and filters with protective plastic bags, then store them in a dry place.

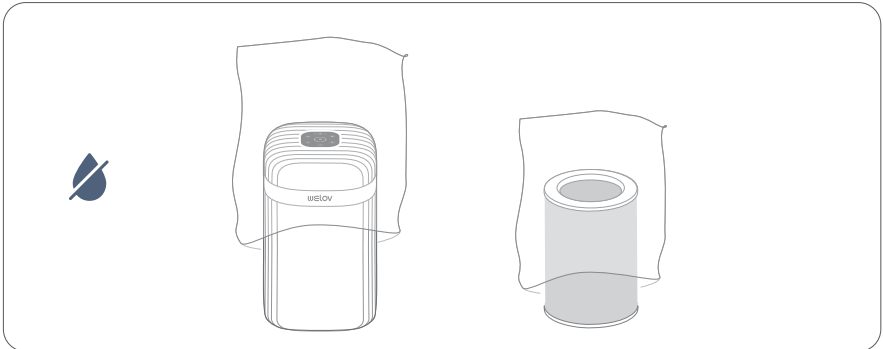

# TROUBLESHOOTING GUIDE

If you need any further assistance, please feel free to contact us. To maintain the air purifier's optimal performance, please regularly clean the air purifier and remove objects that block the air inlet.

Problem	Possible Solution
<p><b>Q1.</b> The air purifier produces an unusual noise after it's turned on.</p>	<p>* Make sure the plastic bag is removed from the HEPA&amp;Activated Carbon Filter and properly installed.</p>
	<p>* Make sure the air purifier is working on a hard, flat, and even surface.</p>
	<p>* The air purifier may be damaged, or there may have foreign objects inside. Please stop using the air purifier and contact us. Do not attempt to repair the air purifier yourself.</p>
<p><b>Q2.</b> An unpleasant odor is coming from the air purifier.</p>	<p>* Clean the pre-filter, or replace the HEPA&amp;Activated Carbon Filter if necessary.</p>
	<p>* Stop using the air purifier and contact us.</p>
<p><b>Q3.</b> The air purifier can't be turned on or stops working.</p>	<p>* Check if the air purifier is plugged in.</p>
	<p>* Check if the power cord is damaged. If yes, stop using the air purifier and contact us.</p>
	<p>* Try to plug the air purifier into a different outlet.</p>
	<p>* The air purifier is malfunctioning. Please contact us.</p>
<p><b>Q4.</b> The air quality is still poor after using the air purifier.</p>	<p>* Make sure the plastic bag is removed from the HEPA&amp;Activated Carbon Filter and properly installed.</p>
	<p>* Tap  to adjust the fan speed to a higher level.</p>
	<p>* Close the doors and windows while using the air purifier.</p>

<p><b>Q4.</b> The air quality is still poor after using the air purifier.</p>	<p>* Please make sure the air inlet and air outlet of the air purifier are not blocked by any objects. Leave 38 cm/15 inches of clearance on all sides of the air purifier.</p>
	<p>* Please check if the pre-filter is clogged by some large particles, such as hair or lint. If yes, please clean the pre-filter.</p>
	<p>* Replace the HEPA&amp;Activated Carbon Filter.</p>
<p><b>Q5.</b> The Check Filter Reset Indicator is still on after I replace the HEPA&amp;Activated Carbon Filter with a new one.</p>	<p>* After replacing the filter, please long press  for 3s until the indicator flashes 3 times to reset the service time.</p>
<p><b>Q6.</b> The HEPA&amp;Activated Carbon Filter is still off after I use the air purifier for 6 months, or it lights up less than 3 months after use.</p>	<p>* The indicator is to remind you to check the HEPA&amp;Activated Carbon Filter. It lights up depending on the use frequency of the air purifier and the air quality. If you don't use your air purifier often, it will take longer to light up. If you use it frequently, it will take shorter to light up.</p>
<p><b>Q7.</b> The touch panel isn't working.</p>	<p>* Ensure the Child Safety Lock is turned off.</p>
	<p>* The air purifier is malfunctioning. Please contact us.</p>
<p><b>Q8.</b> Where to buy HEPA&amp;Carbon Activated Filters ?</p>	<p>* Please contact us to get the purchase link, Thanks.</p>

If your problem is not listed, please contact **Customer Support**.



## **CUSTOMER SUPPORT**

[support@welovhome.com](mailto:support@welovhome.com)

[www.welovhome.com](http://www.welovhome.com)