



Ultrasonic Cool Mist  
Humidifier

# User Manual

## H400/H600



Please read all the instructions before using and keep it for future reference.

# WARRANTY

Welov comes with 1 Year Warranty that begins on the date of purchase.

Welov Corporation warrants all products to be of the highest quality in material, craftsmanship, and service, effective from the date of purchase to the end of the warranty period. The warranty applies to the product and necessary parts and labor relating thereto. The warranty does not apply to damage resulting from failure to follow the operating instructions, accidents, abuse, alterations, or disassembly by unauthorized individuals.

## Extend Your Warranty by 1 Year

Register your product at [www.welovhome.com/registration](http://www.welovhome.com/registration) to extend your 1-year warranty by an additional year.

Please fill out all required fields and include your order ID, place of purchase, and purchase date, if applicable.

If you have product questions or concerns, don't hesitate to contact us directly at:

[support@welovhome.com](mailto:support@welovhome.com)

Welov has an award-winning warranty, exchange, and customer service program that guarantees hassle-free solutions within 24 hours for any issue you might have with this product!

# CONTENTS

|                                      |           |
|--------------------------------------|-----------|
| <b>IMPORTANT SAFETY INSTRUCTIONS</b> | <b>01</b> |
| BEFORE USING THE HUMIDIFIER          | 01        |
| WHEN USING THE HUMIDIFIER            | 02        |
| AFTER USING THE HUMIDIFIER           | 04        |
| <b>WHAT'S INCLUDED</b>               | <b>05</b> |
| <b>SPECIFICATIONS</b>                | <b>05</b> |
| <b>PRODUCT OVERVIEW</b>              | <b>06</b> |
| <b>OPERATION GUIDE</b>               | <b>08</b> |
| ADD WATER                            | 09        |
| POWER ON/OFF AND MIST CONTROL        | 10        |
| AUTO MODE                            | 11        |
| NIGHT LIGHT                          | 12        |
| TIMER                                | 13        |
| SLEEP MODE                           | 13        |
| MEMORY FUNCTION                      | 14        |
| LOW WATER PROTECTION                 | 15        |
| <b>MAINTENANCE AND CARE</b>          | <b>15</b> |
| DAILY MAINTENANCE                    | 16        |
| WEEKLY MAINTENANCE                   | 16        |
| SCALE REMOVAL INSTRUCTIONS           | 16        |
| DISINFECTION INSTRUCTIONS            | 19        |
| DUSTPROOF SPONGE CLEANING            | 20        |
| END-OF-SEASON CARE AND STORAGE       | 21        |
| <b>TROUBLESHOOTING GUIDE</b>         | <b>21</b> |
| CAUTION                              | 25        |

# IMPORTANT SAFETY INSTRUCTIONS

Please read these IMPORTANT SAFETY INSTRUCTIONS before using the humidifier. Some issues could be avoided by doing so during the use of the product, but it is not necessary to follow these instructions completely for operating the humidifier.

- Be aware that high humidity levels may encourage the growth of biological organisms in the environment.
- Do not permit the area around the humidifier to become damp or wet. If dampness occurs, turn the output of the humidifier down. If the humidifier output volume cannot be turned down. Use the humidifier intermittently. Do not allow absorbent materials such as carpeting, curtains, drapes, or table cloths to become damp.
- Unplug the appliance during filling and cleaning.
- Never leave water in the reservoir when the appliance is not in use.
- Empty and clean the humidifier before storage. Clean the humidifier before next use.
- Warning: Micro-organisms that may be present in the water or in the environment where the appliance is used or stored, can grow in the water reservoir and be blown in the air causing very serious health risks when the water is not renewed and the tank is not cleaned properly every 3 days.
- Empty the tank and refill every third day. Before refilling, clean it with fresh tap water or cleaning agents if required by the manufacturer. Remove any scale, deposits, or film that has formed on the sides of the tank or on interior surfaces, and wipe all surfaces dry.

## BEFORE USING THE HUMIDIFIER

1. DO NOT place the humidifier in a wet environment.



2. Please always keep the humidifier out of the reach of patients, children, and pets.



3. Please always place the humidifier on a smooth, flat, lint-free, non-metallic, waterproof and level surface; avoid the direct sunlight.

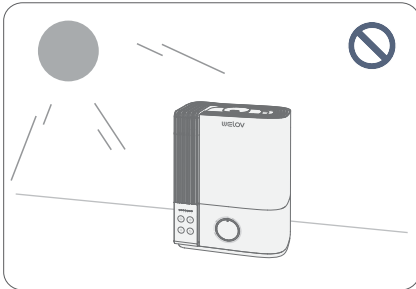

4. DO NOT place the humidifier near open flames or heat sources, such as stoves, ovens, radiators or computers.

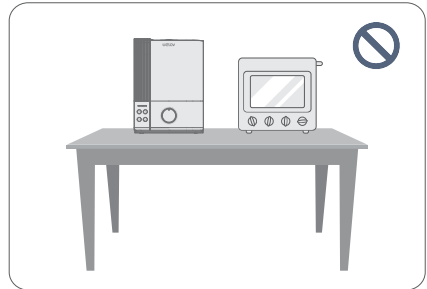

## WHEN USING THE HUMIDIFIER

1. DO NOT plug the power cord into an outlet with wet hands.

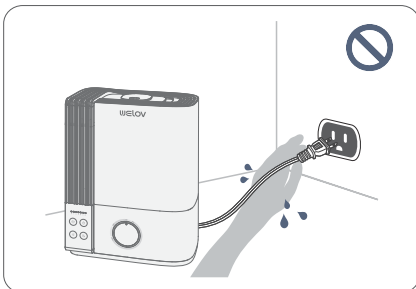

2. DO NOT make the **Nozzle** facing towards the wall or curtains.

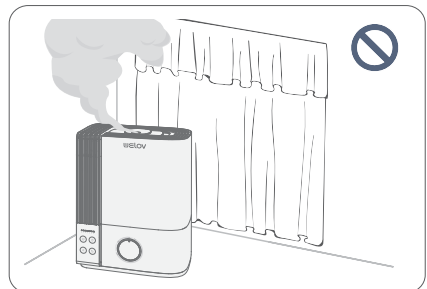

3. DO NOT cover the **Nozzle** with your hand or any other objects when the humidifier is working to avoid damage to the humidifier or injury.

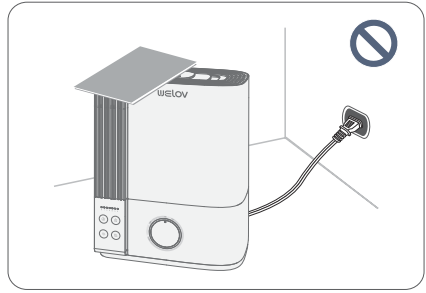

4. DO NOT clean the humidifier when it is connected to a power source or when it is turned on.

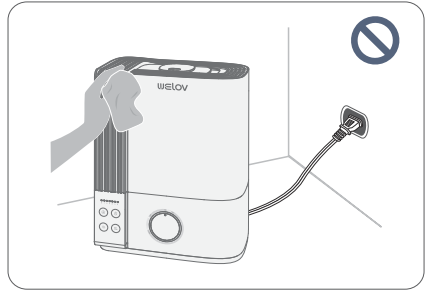

5. DO NOT move or tilt the humidifier during operation.

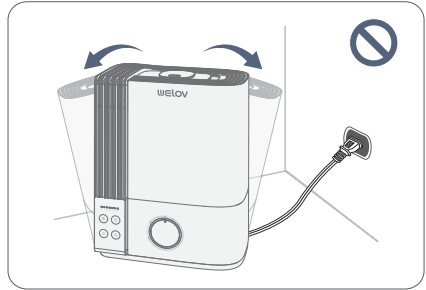

6. The recommended ideal humidity is between 40% - 60%. Please adjust the mist as needed.



## AFTER USING THE HUMIDIFIER

1. Always disconnect the power adapter by unplugging it when the humidifier is not in use.

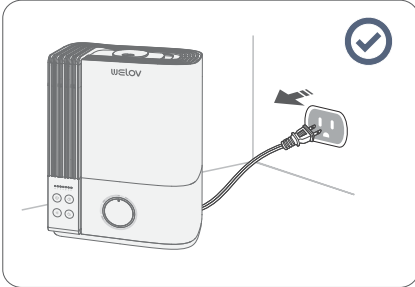

2. The humidifier requires regular cleaning. Please refer to the instructions mentioned in the section of **Maintenance and Care**.



3. DO NOT clean the humidifier immediately after turning it off. Allow the humidifier to cool down completely before cleaning.

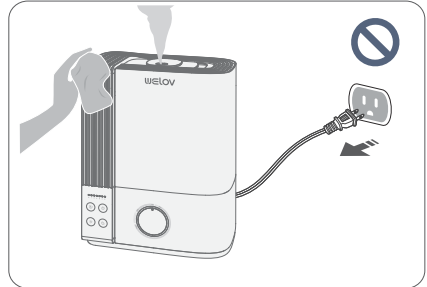

4. DO NOT attempt to repair, or adjust any electrical/mechanical functions of the humidifier by yourself.



Welov will accept no liability or responsibility for fires, explosions or electrical shocks caused by improper operation, dismantling the humidifier or by not adhering to the above safety instructions.

## WHAT'S INCLUDED

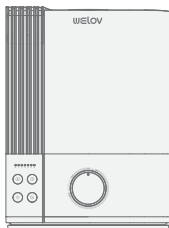

Humidifier



Cleaning Brush



Dustproof Sponge



User Manual

## SPECIFICATIONS

| Model               | Welov H400                                    | Welov H600                                    |
|---------------------|---|---|
| Operating Voltage   | AC 100-240V; 50/60Hz                          | AC 100-240V; 50/60Hz                          |
| Rated Power         | 28W   | 28W   |
| Water Tank Capacity | 4.5L/1.2Gal                                   | 6L/1.6Gal                                     |
| Net Weight          | 1.85Kg/65.3oz                                 | 1.98Kg/69.8oz                                 |
| Dimensions          | 262 × 160 × 312mm/<br>10.31 × 6.30 × 12.28 in | 262 × 160 × 346mm/<br>10.23 × 6.30 × 13.62 in |
| Atomization Amount  | 80-330ml / h                                  | 80-330ml/h                                    |



# PRODUCT OVERVIEW

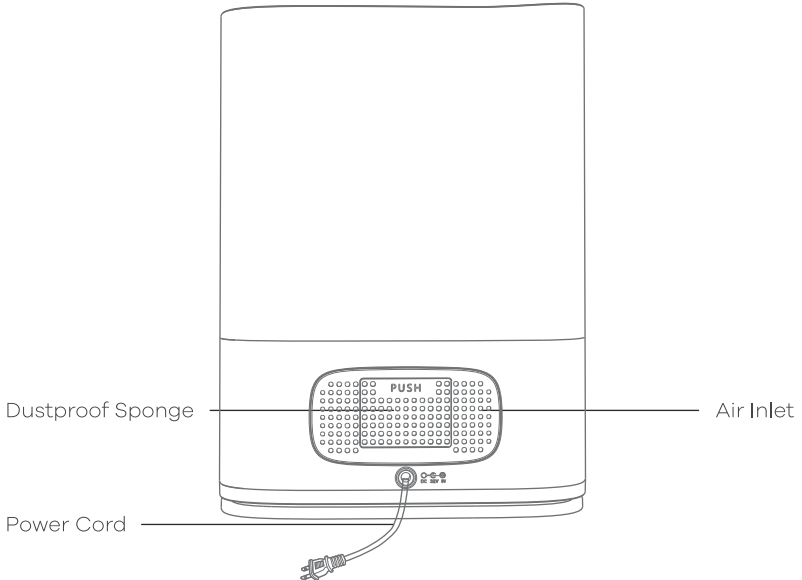
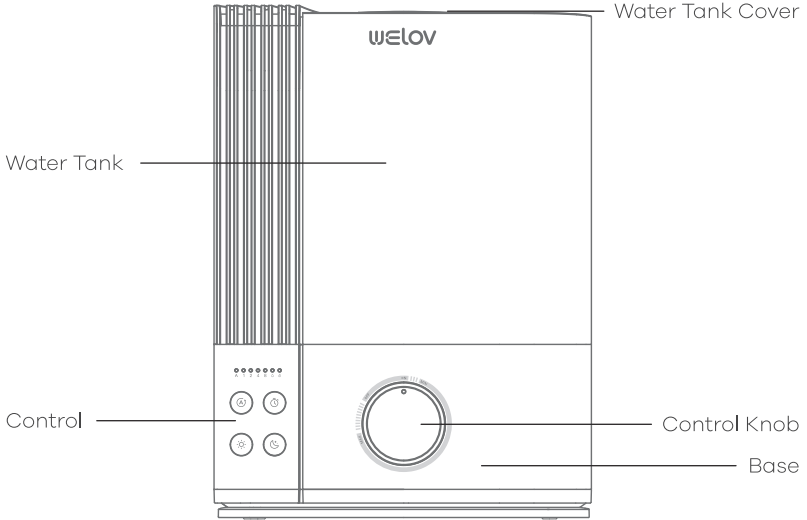

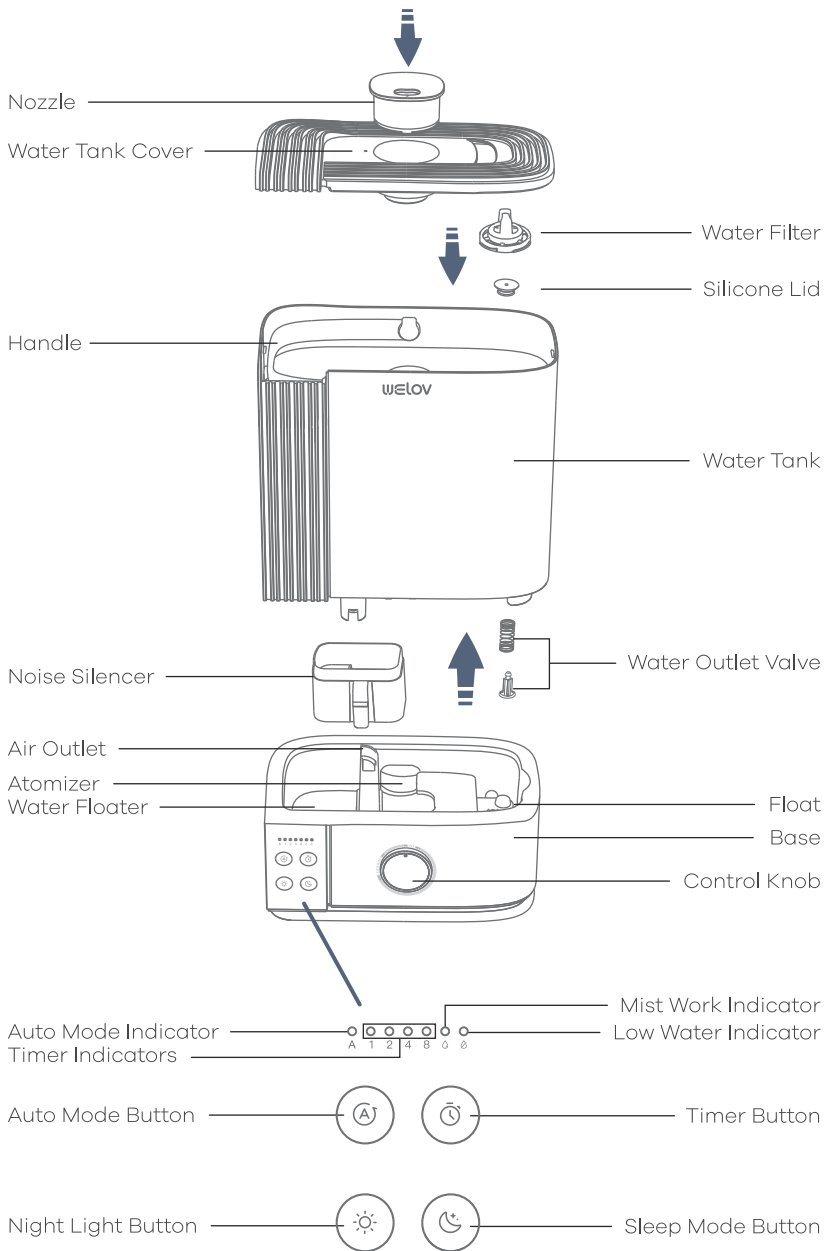

# OPERATION GUIDE

## GETTING STARTED

1. Remove all packaging.
2. Take the water tank off of the base and remove all tape, including any tape on the float. Check to make sure that the water filter is correctly in place. If not, then rotate the filter clockwise to secure it in place.



3. Clean the water tank and water tank cover before first use.

**Note:**

1. When removing and placing the water tank cover, please make sure that the water tank cover and the nozzle arrow mark are not in a straight line.
2. When the nozzle and the arrow mark of the tank cover are in the same direction, the nozzle can be removed for easy cleaning.

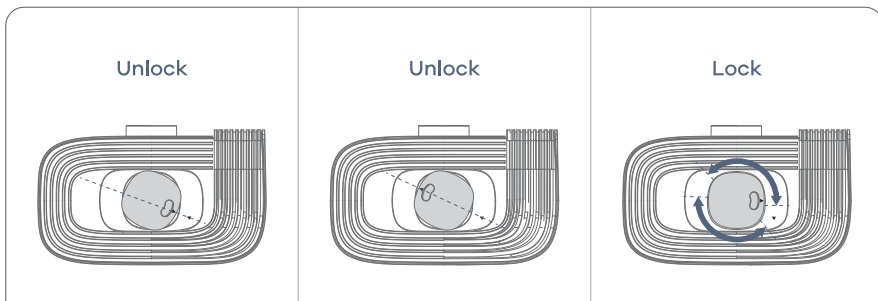

## ADD WATER

1. Remove the water tank cover by holding the nozzle and pulling upward.
2. Use the handles to remove the tank from the base. Fill the tank with Room temperature water. Do not fill with hot water.

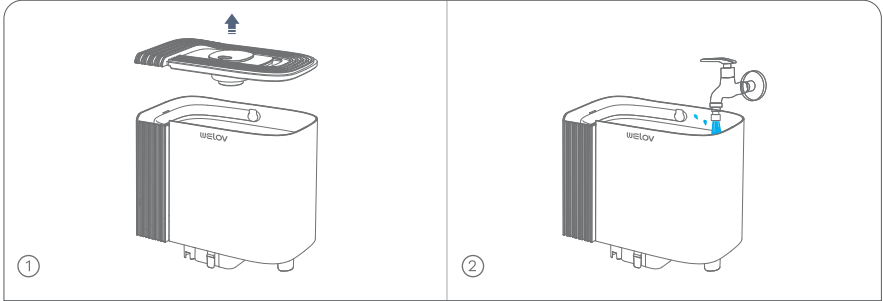

### Note:

1. We recommend using purified or distilled water to fill the tank. Do not fill past the tank's max water line.
2. Do not add water and essential oils directly into the base chamber or mist tube.

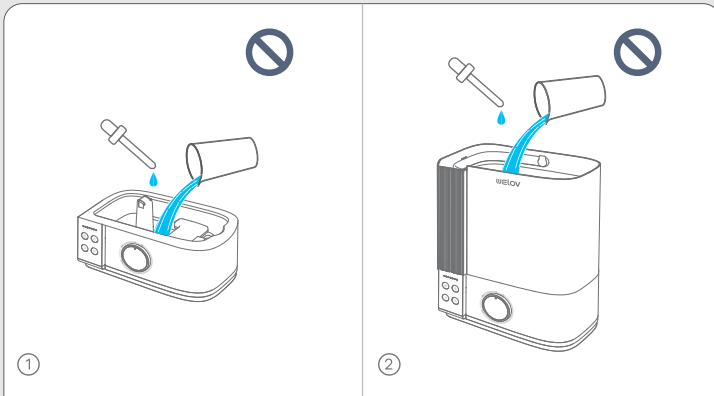

3. Replace the water tank cover and place the tank back on the base. Make sure the nozzle on the watertank cover is placed over the mist tube, or the humidifier may not work correctly.

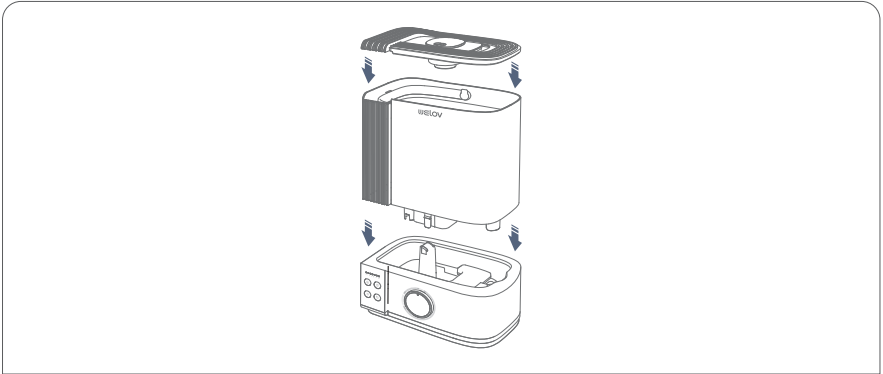

## ⏻ POWER ON/OFF AND MIST CONTROL

### Step 1:

Plug the **Power Cord** into a socket.

### Step 2:

Rotate the Control Knob clockwise to the ON position. The Mist Work Indicator will light up in solid white at the same time, and the mist will be the minimum level by default.

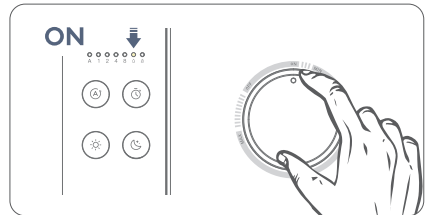

### Step 3:

- ① Rotate the Control Knob clockwise to increase the intensity of mist.
- ② Rotate the Control Knob counterclockwise to reduce the intensity of mist.

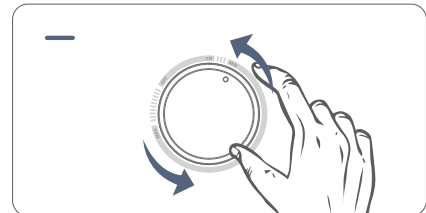
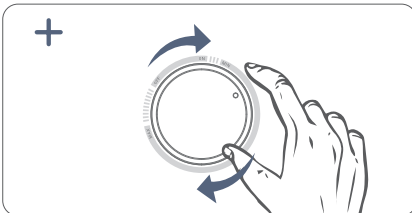

**Step 4:**

Rotate the Control Knob counterclockwise to the OFF position to turn off the humidifier. The white LED Mist Work Indicator will turn off.

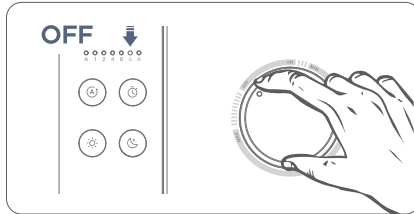

**A) AUTO MODE**

1. Press AUTO Mode Button to turn on the AUTO mode. The AUTO Mode Indicator will light up.
2. Press AUTO Mode Button again to turn off the AUTO mode. The AUTO Mode Indicator will be off.



**Note:**

1. The humidifier has a humidity sensor to detect the humidity, and automatically open or close the MIST based on the actual humidity.
2. When the humidity is lower than 65% RH, the humidifier will keep MIST, the AUTO Mode Indicator light is yellow or blue.
3. When the humidity is higher than 65% RH, the humidifier will stop MIST, the AUTO Mode Indicator light is green.

| HUMIDITY    | MIST    | INDICATOR COLOR |
|-------------|---------|-----------------|
| < 50%RH     | 300ml/H | Yellow          |
| 51%RH-59%RH | 190ml/H | Blue            |
| 60%RH-65%RH | 80ml/H  | Blue            |
| > 65%RH     | 0ml/H   | Green           |

## NIGHT LIGHT

- 1 Press the **Night Light** button to turn on the light at the bottom. The default brightness is set to the medium level.

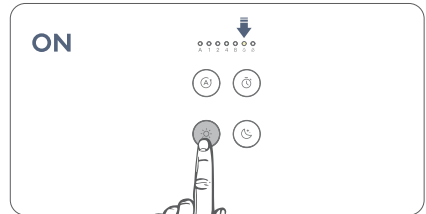

- 2 Long press the **Night Light** button for 1.5S to adjust the brightness.

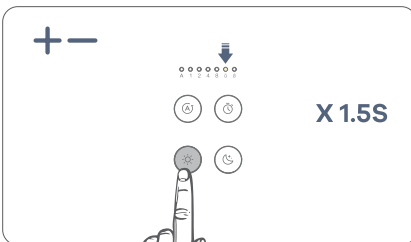

- 3 Press the **Night Light** button again to turn off the light at the bottom.

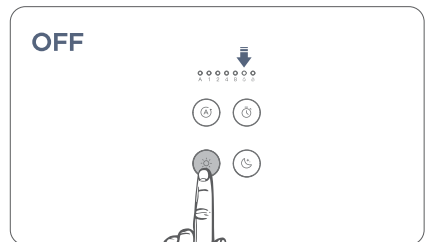

### Tip:

**Night Light** function can be used alone when the humidifier is not producing mist.

## TIMER

- 1 Press the **Timer** button once at a time to set a timer among 1H, 2H, 4H and 8H and the corresponding indicator will light up in warm white.

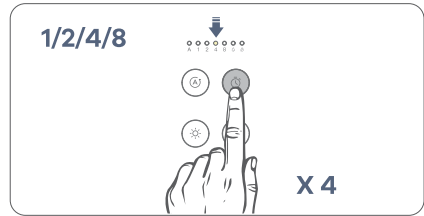

- 2 Press the **Timer** button for the fifth time to disable the **Timer** function, and the **Timer Indicators** will be off.

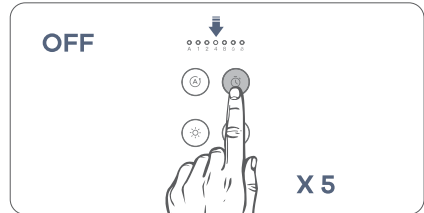

- 3 After the **Timer** is up the humidifier will stop producing mist and the **Water Level Indicator** will be off.

**Tip:**  
Night Light function is not affected by the **Timer**.

- 4 Long press the **Timer** button for 1.5S to cancel the timer setting immediately.

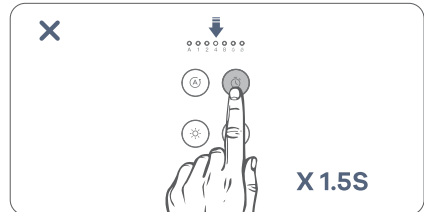

## SLEEP MODE

- 1 Press the **Sleep Mode** button to enable the **Sleep Mode**. All lights, including **Water Level Indicator**, **Low Water Indicator**, **Timer Indicator** and **Night Light** will be off, and the humidifier will continue to produce mist.

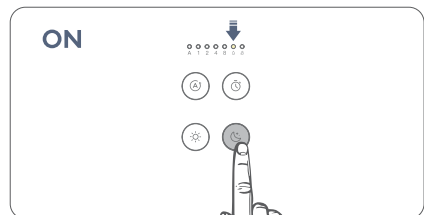



- 2 In the **Sleep Mode**, press any button or the **Power/Mist Control** to wake up the humidifier.

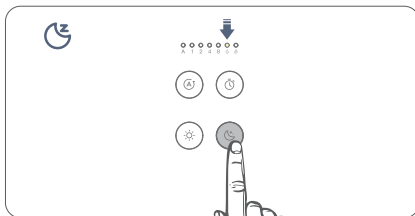

- 3 After waking it up, you can make some adjustment within 3S, such as setting a **Timer** or adjusting the **Night Light** brightness. After finishing the above settings for 1S, the humidifier will return to the **Sleep Mode**.

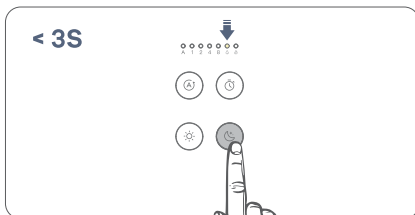

- 4 Press the **Sleep Mode** button again to exit the **Sleep Mode**, and the humidifier will return to the state before enabling the **Sleep Mode**.

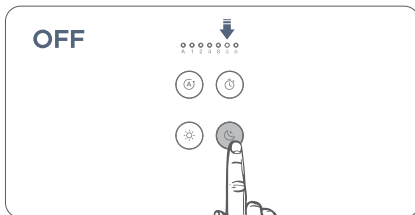

**Tip:**

If there is no operation within 3S, the humidifier will return to the state before waking it up.

## MEMORY FUNCTION

- 1 If you turn off the humidifier without unplugging the adapter and then turn it on again, the mist intensity of the humidifier will be the same as before the humidifier was turned off.
- 2 If you turn off the **Night Light** without unplugging the adapter and then turn it on again the **Night Light** brightness will remain the same as before the light was turned off.

**Tip:**

The memory function does not apply to the **Timer** and **Sleep Mode** functions.

## LOW WATER PROTECTION

When there is not enough water in the **Water Reservoir**, the **Low Water Indicator** will turn red.

The humidifier will stop producing mist to prevent it from overheating and damaging the **Atomizer**.

## MAINTENANCE AND CARE

### Important:

① DO NOT submerge the **Base** in the water.

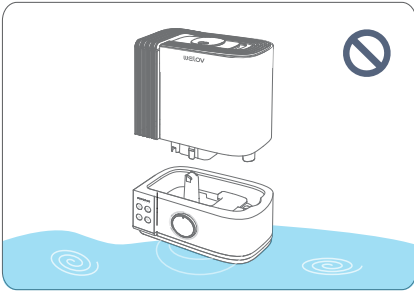

② DO NOT wash any parts of this humidifier in the dishwasher; otherwise, it will damage the humidifier.

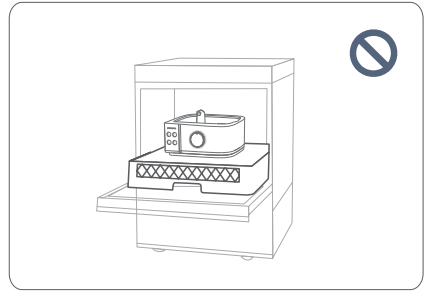

③ Make sure the water does not enter the **Base** through the **Air Outlet**, **Air Inlet** or **Power/Mist Control**.

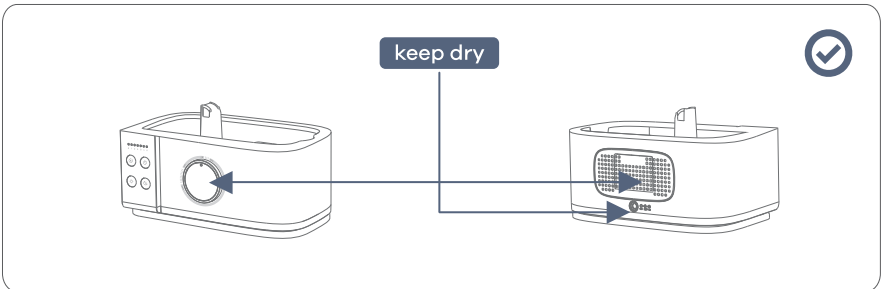

## DAILY MAINTENANCE

**Step 1:** Turn off the humidifier and unplug the **Power Adapter** from the socket.

**Step 2:** Drain water from the **Water Tank, Water Reservoir, and Base**.

## WEEKLY MAINTENANCE

- 1 To properly clean your humidifier, we recommend that you remove scale and disinfect the humidifier separately.
- 2 DO NOT mix vinegar and bleach solution. To avoid damage to the humidifier, do not use more than 1 teaspoon of bleach per gallon of water.

## SCALE REMOVAL INSTRUCTIONS

### Step 1:

Turn off and unplug the humidifier.

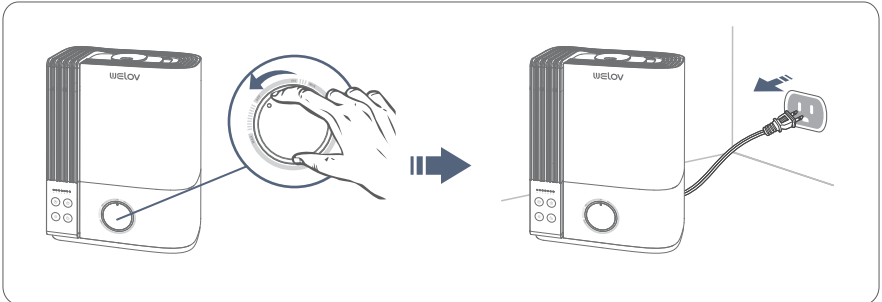

### Step 2:

① Separate the Water Tank from the Base, then remove the Water Tank Cover.

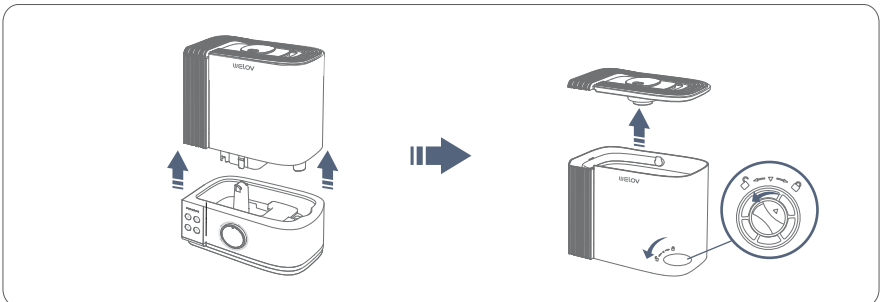

② Drain water from the **Water Tank** and **Base**, then remove all accessories and set aside.

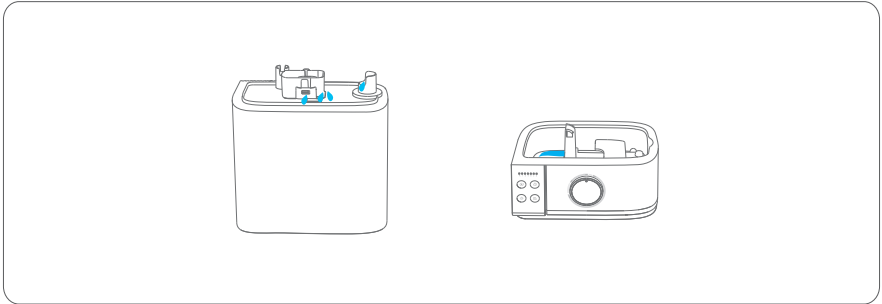

**Step 3:**

① Fill the **Water Tank** halfway. Add in 1 teaspoon of undiluted distilled white vinegar.

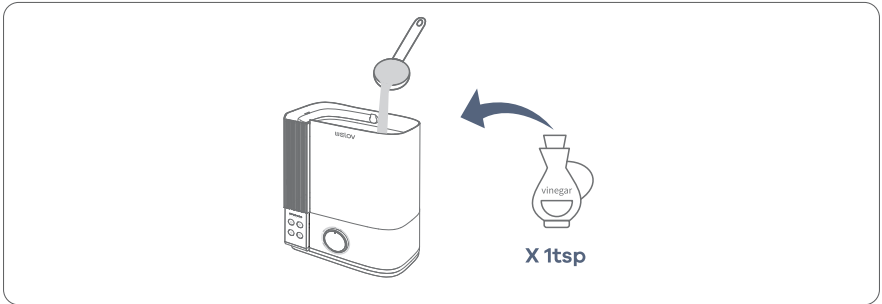

② Attach the Water Tank Cover and shake for 15 seconds.

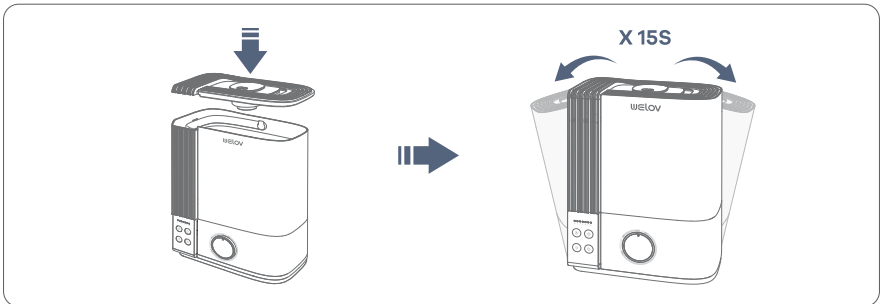

**Step 4:**

Place the **Water Tank** back to the **Base**. The vinegar solution will enter the **Water Reservoir** to loosen mineral scale on the **Atomizer, Water Floater** and the bottom of the **Water Tank**. Leave it for 15-20minutes.

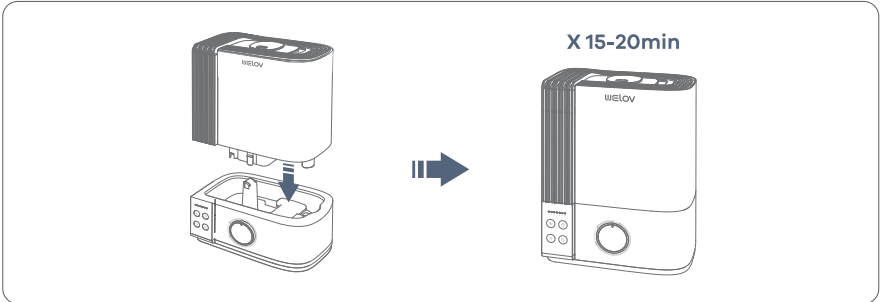

**Step 5:**

① Uncap the Water Tank Cover and drain the solution

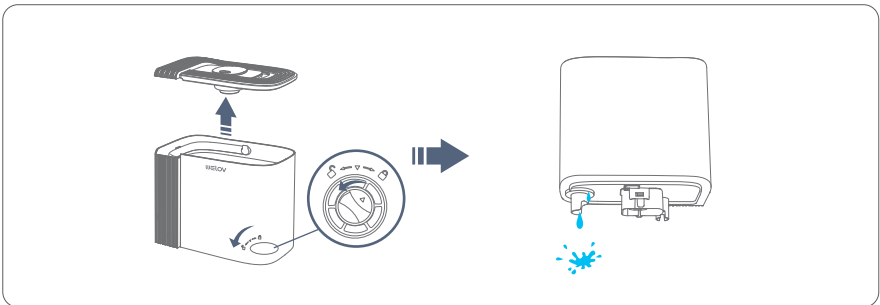

② Wipe the **Atomizer** and **Floater** with a soft cloth to remove loose mineral deposits.

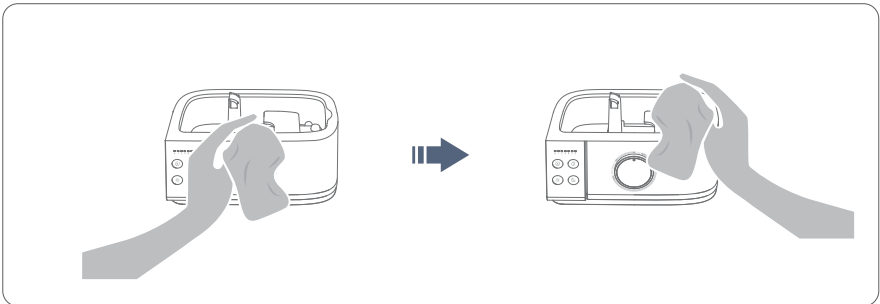

**Step 6:**

Wash both the **Water Reservoir** and **Water Tank** until the smell of vinegar ( for scale removal) or bleach solution ( for disinfection, see below) is gone.

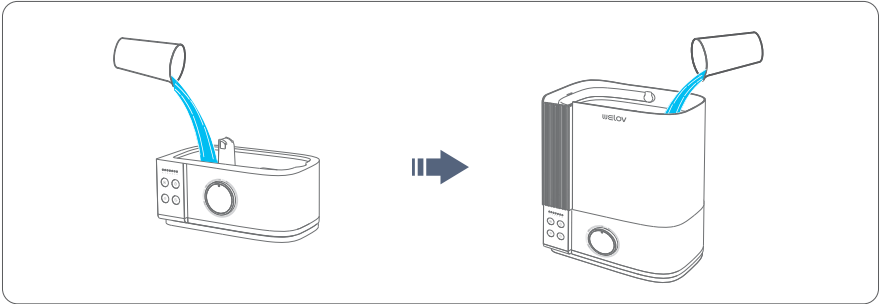

## DISINFECTION INSTRUCTIONS

**Step 1:**

Follow steps 1 to 2 of the scale removal instructions in the previous section.

**Step 2:**

① Fill the **Water Tank** halfway. Add  $\frac{1}{2}$  teaspoon of bleach into the **Water Tank**.

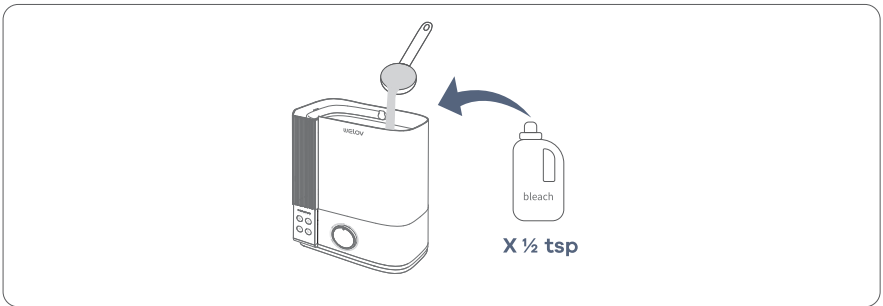

② Attach the Water Tank Cover and shake for 15 seconds.

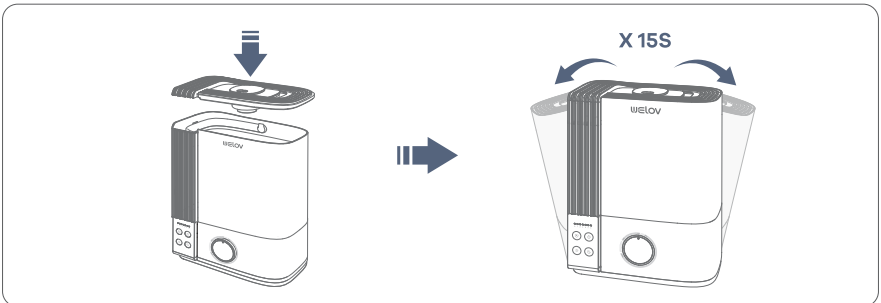

### Step 3:

Place the **Water Tank** back to the **Base**. The bleach solution will enter and disinfect the **Water Reservoir** and the other components. Leave it for 15-20 minutes.

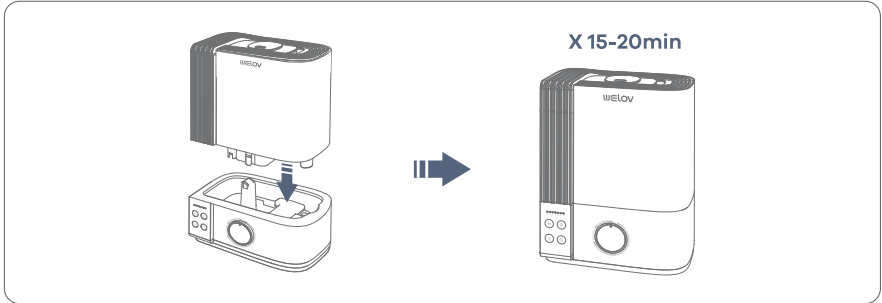

### Step 4:

Follow steps 5 to 6 of the previous section for scale removal to complete the disinfection of the humidifier.

#### Note:

Do not remove the Float during cleaning, scale removal, and disinfection.

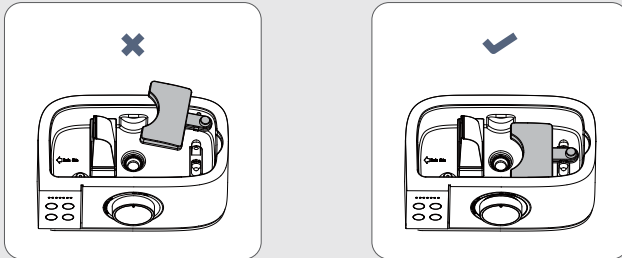

## DUSTPROOF SPONGE CLEANING

Clean the **Dustproof Sponge** (located on the back of the **Base**) with water or detergent monthly, then put it back in place.

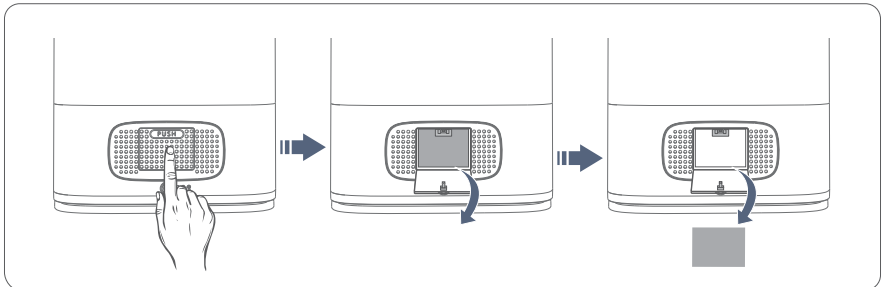

## END-OF-SEASON CARE AND STORAGE

- 1 Follow the cleaning instructions when the humidifier will not be used for at least one week, or at the end of the season. Remove all accessories from the humidifier, and allow the humidifier and accessories to dry completely before storing it.
- 2 DO NOT store water in the **Base, Water Reservoir** or **Water Tank**.
- 3 Pack the humidifier safely and store it in a cool, dry place.

## TROUBLESHOOTING GUIDE

- 1 If you need any further assistance, please feel free to contact us at [support@welovhome.com](mailto:support@welovhome.com).
- 2 Failure to keep the humidifier clean and free of mineral deposits may affect the operation of it.

### Q1. The water level indicator is off.

| Possible Cause                    | Solution  |
|-----------------------------------|---|
| The humidifier is not plugged in. | Make sure the humidifier is properly plugged into a socket. |
| No power from the power outlet.   | Try to use other power outlets.                             |
| The humidifier is not turned on.  | Check if the humidifier has been turned on.                 |

### Q2. The low water indicator stays red.

| Possible Cause                   | Solution   |
|----------------------------------|--|
| No water in the Water Reservoir. | Make sure the <b>Water Outlet Valve</b> is fixed correctly to the bottom of the tank so that water can pass through to the Base. |
| <b>Water Floater</b> was stuck.  | Adjust the <b>Water Floater</b> to a horizontal position and make sure it can rise with water.                                   |



Q3. The water level indicator is white but there is no or little mist produced.

| Possible Cause                            | Solution  |
|---|---|
| Not enough water inside the tank.         | Refill and place the <b>Water Tank</b> back in place.   |
| Mist level is set too low.                | Adjust the humidifier to the maximum mist.  |
| Mineral build up on the <b>Atomizer</b> . | Check if any air comes out from the <b>Nozzle</b> . If not, clean water scale on the <b>Atomizer</b> as instructed. |
| The <b>Base</b> might be overfilled.      | Remove the tank, empty the <b>Base</b> , then place the filled tank on the empty <b>Base</b> .                      |

Q4. Tank leakage.

| Possible Cause                       | Solution   |
|--------------------------------------|--|
| Tank may be damaged.                 | Check for possible cracks in the tank. If yes please replace it.   |
| <b>Water Outlet Valve</b> was stuck. | Make sure the <b>Water Outlet Valve</b> is fixed correctly to the bottom of the tank so that water can pass through to the Base. |

Q5: The mist makes the surrounding tables or floors damp. Condensation occurs around humidifier or on windows/walls.

| Possible Cause                                | Solution   |
|---|--|
| Mist level is set too high for the room size. | <ol style="list-style-type: none"> <li>1. Check if the room is too humid and adjust the humidifier to a lower mist. 40%-60% works best.</li> <li>2. Open door and windows or change to a larger room.</li> </ol> |

|   |   |
|---|---|
| Air Inlet was blocked.                      | Make sure the humidifier is placed $\geq 12$ inches away from the wall. Make sure the <b>Nozzle</b> is not facing the wall or window. |
| Low room temperature leads to liquefaction. | Adjust the room temperature to 25°C/77°F.   |

**Q6. The humidification is too poor.**

| Possible Cause                               | Solution  |
|--|---|
| Mist level is set too low for the room size. | 1. Adjust the humidifier to the maximum mist.<br>2. Close door or windows to reduce air ventilation, or change to a smaller room. |
| Air Inlet was blocked.                       | Make sure the humidifier is placed $\geq 12$ inches away from the wall. Make sure the Nozzle is not facing the wall or window.    |
| Low room temperature leads to liquefaction.  | Adjust the room temperature to 25°C/77°F.   |

**Q7. White dust appears or the black coating on the base flakes off.**

| Possible Cause                               | Solution  |
|--|---|
| The tap water may contain too much minerals. | Please replace it with filtered or distilled water. |

**Q8: Strange odor.**

| Possible Cause               | Solution   |
|------------------------------|--|
| Please clean the humidifier. | 1. Please make sure to clean the humidifier according to the instructions.<br>2. Leave the empty <b>Water Tank</b> in a cool place for 12 hours without covering <b>Tank Cap</b> . |

Q9: Strange water noise.

| Possible Cause                                      | Solution                           |
|---|------------------------------------|
| Water is going down to the <b>Water Reservoir</b> . | This is normal while it is working |

Q10: Humidifier is getting too hot.

| Possible Cause                     | Solution  |
|------------------------------------|---|
| The humidifier works for too long. | Please power it off and put it in a well ventilated place for 10 minutes. |

## CAUTION

 The symbol indicates DC voltage

 RECYCLING

Users should only operate the humidifier once they have understood all the following important safety instructions. Users who have a disability and need assistance are responsible for seeking support and ensuring their own safety in line with the instructions given in this manual.

\*Children should be supervised to ensure that they do not play with the appliance.

\*Unplug the appliance during filling and cleaning.

\*Please confirm the composition and quantity of solution to be used during maintenance. If salt is included, it is recommended not to use excessive amounts of solution.

\*The appliance is not to be operated from a dc supply. If the supply cord is damaged, it must be replaced by the manufacturer, its service agent or similarly qualified persons in order to avoid a hazard.

\*The appliance is only to be used with the power supply unit provided with the appliance.



# CUSTOMER SUPPORT

[support@welovhome.com](mailto:support@welovhome.com)

[www.welovhome.com](http://www.welovhome.com)